



*The absolute opposite of ordinary*

## **G902 Dual Channel UHD Video Wall Controller**

### **User Guide**

*Input: up to 4096\*2160 @60Hz, 7680\*2160 @30Hz,  
7680\*1200 @60Hz in HDMI2.0b, 4:4:4 chroma sampling*

*Programmable Output resolution: up to 4096\*2267/60Hz  
or 7680\*1234/60Hz, HDMI2.0, RGB 4:4:4*

*Selectable output refresh rate: 24/30/50/60/100/120Hz*

*Support HDR 10, BT 2020 signal processing*

*PIP/POP & 3/4 split view MultiViewer*

*3D format conversion*

**(Important Note: If the output resolution can't be supported by the monitor, user will not see any image on the screen)**



Technical support:

E-mail: [sales@vnstw.com](mailto:sales@vnstw.com)

Tel: +886-2-2792-2819 Cell: +886-935-678-033

Skype: vns-inc Version: 1.05

Website: [www.vnstw.com](http://www.vnstw.com)

## Table of Contents

Disclaimer/Copyright statement.....	3
Warranty/RMA and FCC/CE statement.....	3
<b>Introduction.....</b>	<b>4</b>
 <b><u>User Guide</u></b>	
1. How to use IR Remote Controller.....	5
1.1. Key pad functions and extension cable.....	5
1.2. Change OSD language.....	6
1.3. Individual OSD control in multiple unit application.....	6
1.4. OSD Lock and Unlock.....	6
1.5. Change OSD location.....	6
2. System Reset.....	7
3. Front panel.....	8
4. Back panel.....	8
5. Input signal and input port configuration.....	9
6. Output signal and output port configuration.....	10
7. Typical system connection.....	10
8. Select input port	
8.1. Select input port from OSD.....	11
8.2. Select input port from remote controller.....	11
9. Set output resolution and signal type .....	12
9.1. Select output resolution from remote controller.....	12
9.2. Select output resolution from OSD.....	12
9.3. Programmable output resolution.....	13
9.4. Enable 10-bit deep color output .....	14
9.5. HDR (BT.2020) processing.....	14
10. How to check system information.....	15
11. System Control and setup.....	16
11.1. Box ID.....	16
11.2. Multi-units controlled by one remote controller.....	17
11.3. RS232 setting.....	17
11.4. Ethernet setting.....	17
12. PIP/POP multiple image display	
12.1. PIP/POP main menu.....	19
12.2. PIP (picture in picture) .....	23
12.3. POP (PBP) (Picture outside picture) .....	23
13. Quick PIP ON/OFF and two input seamless swap.....	26
14. Advanced system settings	
14.1. Image rotation and flip.....	27

---

14.2. Image cropping in main and PIP/POP (sub-images) .....	28
14.3. Flexible aspect ratio adjustment.....	28
14.4. System Standby and automatically turn off output Signal.....	29
14.5. Change Background Color in blue or black.....	29
14.6. Native 1:1 pixel to pixel image display mode.....	30
14.7. Turn off splash screen Logo.....	30
14.8. Image Freeze.....	30
14.9. Audio output setting.....	31
14.10. HDCP control.....	31
15. Video Wall settings.....	32
15.1. [Zoom] – Split Source Image.....	32
15.2. [Pan] – Assign Image Position.....	33
15.3. [Overlap] – Bezel Compensation and Position Alignment.....	34
15.4. [Position] – Image Position adjustment.....	34
16. Passive/Active 3D application and 3D format conversion.....	35
17. WebGui and GCT PC Tool (GeoBox Control Tool)	
17.1. WebGui.....	38
17.2. UHWall Manager (GCT) PC Tool.....	39
18. Save System Settings through Remote Controller.....	39
19. Load Profile Index through Remote Controller.....	40

### **Application case study**

20. Multi-viewer application.....	41
20.1. Two 3 split views & [SBS 2/1] in one UHD monitor.....	41
20.2. 4 split views in one UHD monitor.....	43
21. Conventional video wall application	
21.1. Case study A--Conventional 4K video wall.....	43
21.2. Case study B--Video wall with PIP in each monitor.....	43
21.3. Case study C--True 8k/2k video wall with 2 UHD monitors.....	45
21.4. Case study D--Multiple units cascaded to build different size video wall.....	46
21.5. Case study E--Various video wall with monitor at landscape and portrait position...	46
22. Creative video wall application.....	47
23. LED application: split and crop image for LED display.....	48
24. Front end processor for large display	
24.1. Split 8k/2k image for 4k projector edge blending.....	49
24.2. Adjust aspect ratio and add PIP in projection system.....	50
24.3. 3 split views in projection system.....	51

### **Technical support**

25. Trouble shooting	
25.1. No image or unstable image on the screen.....	51
25.2. Intermittent or loss of input signal.....	52

25.3. Video Quality issue..... 52

25.4. Abnormal display in Front panel LED indicators..... 53

25.5. Synchronization issue in the outputs..... 53

25.6. Call for technical support..... 53

26. Safety precaution and maintenance..... 54

27. Warranty and RMA policy..... 54

**Specifications**..... 56

**Revision history**..... 57

**Disclaimer/Copyright Statement**

Copyright 2022, VNS Inc. All Right Reserved

This information contained in this document is protected by copyright. All rights are reserved by VNS Inc. VNS Inc. reserves the right to modify this document without any obligation to notify any person or entity of such revision. Copying, duplicating, selling, or otherwise distributing any part of this document without signing a non-disclosure agreement with an authorized representative of VNS Inc. is prohibited. VNS Inc. makes no warranty for the use of its products and bears no responsibility for any error of omission that may appear in this document.

Product names mentioned herein are used for identification purposes only and may be trademarks of their respective companies.

**Limited Warranty and RMA statement**

This device is designed and tested to the highest standards and backed by two years' parts and labor warranty. Warranties are effective upon the first delivery date to the end customer and are non-transferable. Warranty related repairs include parts and labor, but do not include repair of faults resulting from user negligence, special modifications, abuse (mechanical damage), shipping damage, and/or other unusual damages. The customer shall pay shipping charges when the unit is returned for repair. Manufacturer will pay shipping charges for return shipments to customers.

Manufacturer does not assume responsibility for consequential damages, expenses or loss of revenue, inconvenience or interruption in operation experienced by the customer. Warranty service shall not automatically extend the warranty period.

User can pay extension fee to extend the warranty period. Please contact us for more details. In the event that a product needs to be returned for repair, inform manufacturer and ask for a Return Material Authorization number.

**FCC/CE statement**

This equipment has been tested and found to comply with the limits for a Class A digital device, pursuant to part 15 of the FCC Rules. These limits are designed to provide reasonable protection against harmful interference when the equipment is operated in a residential / commercial environment. This equipment generates, uses, and can radiate radio frequency energy and, if not installed and used in accordance with the instruction manual, may cause harmful interference to radio communications. Operation of this equipment in a residential area is likely to cause harmful interference in which case the user will be required to correct the interference at his own expense.

## **Introduction**

G902 is multi-function signal processor with 8k/2k 30Hz, 4k/60Hz input and output. Each box can split signal into two outputs with programmable output resolution in each channel and be served as video wall controller to display all-in-one content across entire video wall as well as discrete true 4k/60 content in each 4k monitor. It can be serves as multi-viewer to display 3/4 split view contents in one monitor. Multiple units of G900 can be cascaded to build all kind of video wall system.

One G902 has two 4k/60 output channels and 5x HDMI 2.0 input ports. One input port is shared with two channels and each channel has two independent input ports. Input supports up to 4096\*2160 @60Hz, 7680\*2160 @30Hz with 4:4:4 chroma sampling. One HDMI 2.0 loop out port is to provide daisy chain connection with multiple units to get different configuration.

Programmable output range is from 800-7680 (8 Px/step under 230Mhz, 16 Px/step above 230Mhz) in horizontal and 600-3840 (with 1 pixel/step) in vertical. It supports up to 4096\*2267 @60Hz or 7680\*1234 @60Hz in each channel. The maximum pixel clock is limited to 600 MHz. Output refresh rate is selectable from 24/30/50/60/100/120Hz. It supports various input sources and input timings, including non-VESA standard input timings.

It is integrated with 10-bit high end processor, motion adaptive de-interlace, low angle smooth algorithm, 3:2/2:2 pull-down cadence. Programmable EDID enables optimized input timing to get the best video performance.

It can execute color adjustment in Brightness, Contrast, Hue, Saturation, Sharpness, color temperature and discrete RGB gain adjustment. **Automatically detect and process HDR BT. 2020 input signal and output with full color 4:4:4 RGB SDR signal.** User can select deep color mode with true 10-bit color output to get smooth gradient color.

Video wall function in G902 can crop specific location & resolution in source image for each output. Overlap function allows user to change image position, aspect ratio and cropping area up to +/-1800 pixels in each edge. User can adjust aspect ratio and image position freely. Independent image 90/180/270 degrees flip and rotation is also available in each channel. User can build UHD video wall with any LCD array at landscape and portrait directions.

PIP (picture in picture) and POP (side by side or top/bottom) is standard functions in each output channel. 3 split views MultiViewer function is embedded. 4 split views can be implemented through dual channels. Both main and sub-images can be flipped and rotated at 90/180/270 degrees and quick seamless swap. The cropping range and position in both main and sub-image are adjustable. Maximum display windows in the video wall with 2 monitors is 5.

3D function is integrated in G902. It can convert 3D format (side by side, top/bottom, frame sequential, Line interleaved, frame packed, discrete dual camera...) into side by side, top/bottom and frame sequential 3D output format. It can also decode 3D signal into discrete RH or LH for passive display.

User can use IR controller, USB, Web Gui and Ethernet for system operation and setup. 10 custom settings can be saved and recalled. It is designed to work in 7/24 working environment and provides easy configuration, low entry barrier, cost effective, reliable and flexible solution.

# User Guide

## 1. How to Use IR Remote Controller

### 1.1. Key pad functions and extension cable

- IR remote controller has full functions for the operation of G902.
- IR receiver is on Front Panel. One 3.5ø mm audio connector for IR extender is located at Back Panel of G902. 1.8m IR extension cable is equipped in the packing. User can add audio cable to extend the control distance up to 20 meters.

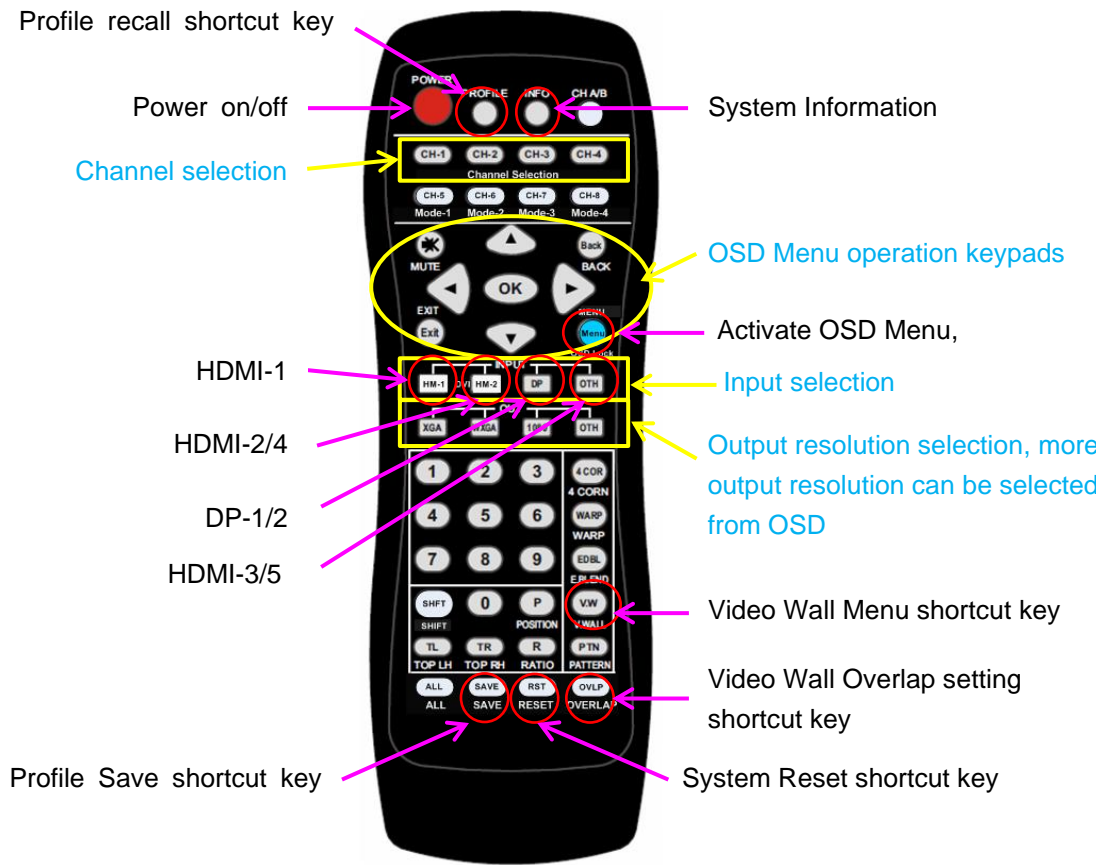

## 1.2. Change OSD language

User can change OSD language through below OSD menu:

[Options]→ [Language]→ select [English], [繁體中文], or [簡體中文]

## 1.3. Individual OSD control in multiple unit application

When multiple units are used and all boxes or IR extender receivers are installed together, user can control individual unit through below method:

- To Press 851 number keys on remote controller, then all the following operations in remote controller will take effect only in ID #1 GeoBox and lock all other GeoBox. User can see flashing LED on the Front Panel of the locked units.
- To Press 853 will only unlock ID # 3 GeoBox for further OSD operation.
- To press 850 will unlock all GeoBox OSD menu. Remote controller can access to all GeoBox simultaneously.

## 1.4. OSD Lock and Unlock

To press MENU key on remote controller for 5 seconds will LOCK the OSD. User will see [Menu is Locked] message. To press another 5 seconds on MENU key will UNLOCK the OSD. User will see [Menu is Unlocked] message. The Power LED will show flashing light with 1 second interval.

## 1.5. Change OSD location

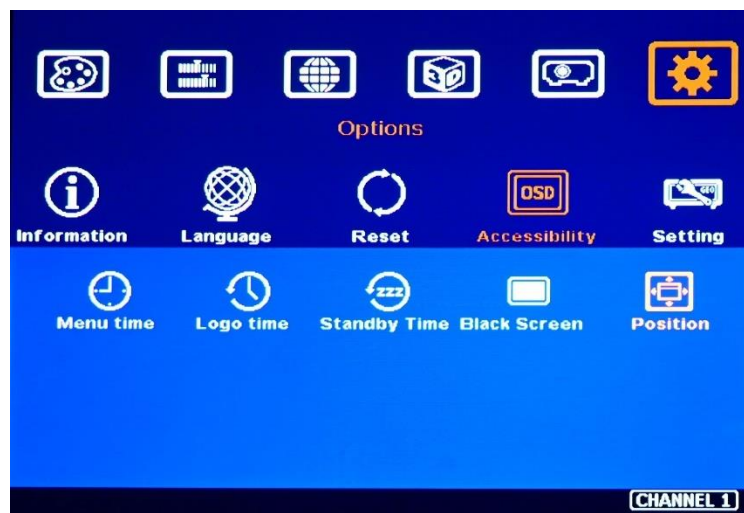

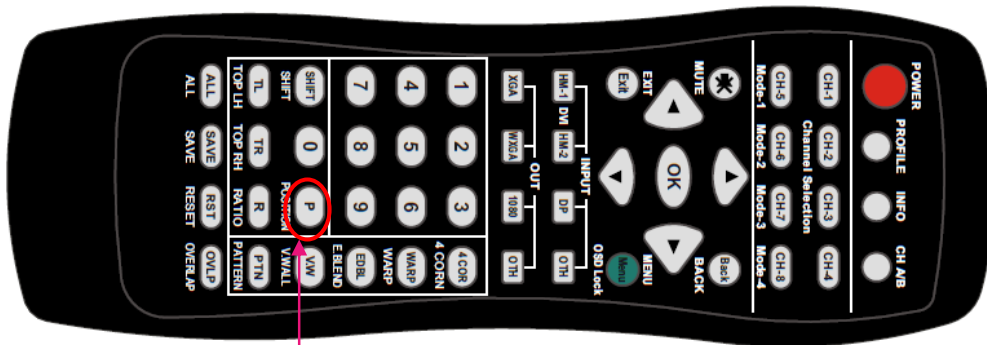

Please click [Position] hotkey to activate OSD position shift menu, then use Direction key to shift OSD position to desire location.

## 2. System Reset

### 2.1. Complete system reset through RESET hole

- Insert small pin into RESET hole on back panel for 5 seconds will reset the system to default settings. User will see “Reset to Default” message.
- Reset through RESET hole will erase all the settings saved inside G902, including Profile Index Data.

### 2.2. Reset system but keep data in Profile Index

- User can Reset through OSD menu under: [Options]→ [Reset]→ [Reset All]
- This reset will take effect only for one processing channel only and the data inside Profile Index will not be erased.

### 2.3. Reset system through GCT or WebGui

- User can also reset system through GCT or WebGui. It will reset all channels at the same time. Please see more details in PC tool application.



### 3. Front panel

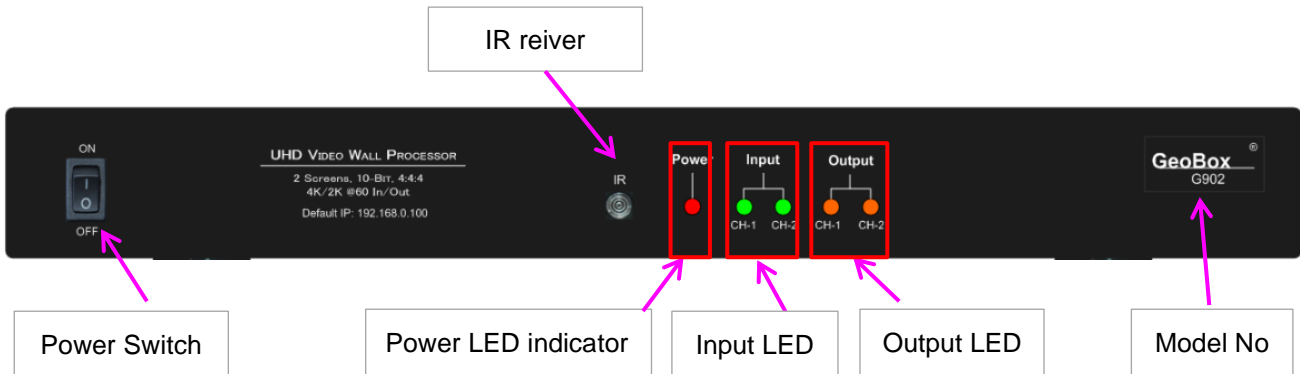

- Input LED will turn to Green when G902 has detected input signal.
- Output LED will turn to Orange when G902 has detected the device in the output.
- **Power LED:**
  - Red: Power connected and has been turned off by remote controller. Need to turn on by remote controller again.
  - Green: Power on
  - Power LED flashing at 0.5 second interval: OSD locked through Menu. Hold Menu key for 5 seconds to unlock.
  - Power LED flashing at 1 second interval: OSD locked through 85x command. Press 850 on remote controller number keys to unlock OSD.

### 4. Back panel

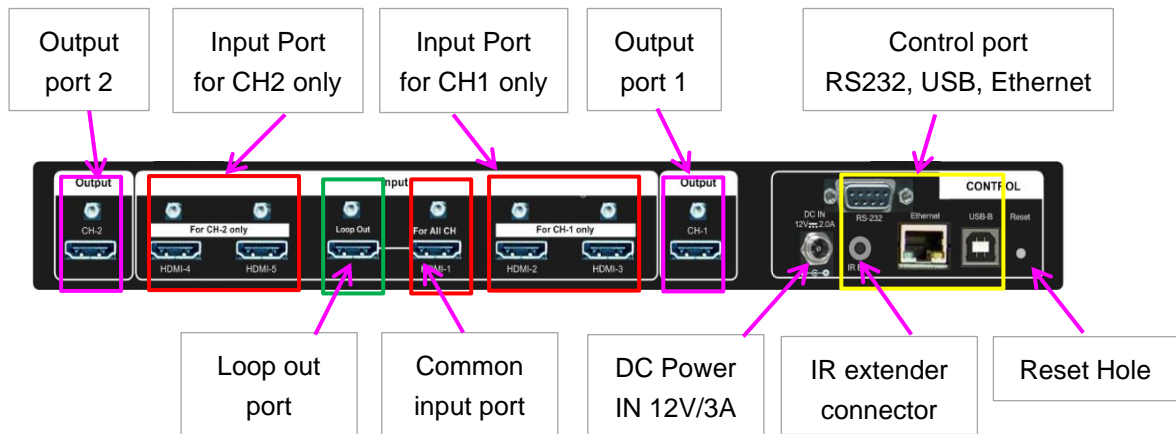

## 5. Input signal and input port configuration

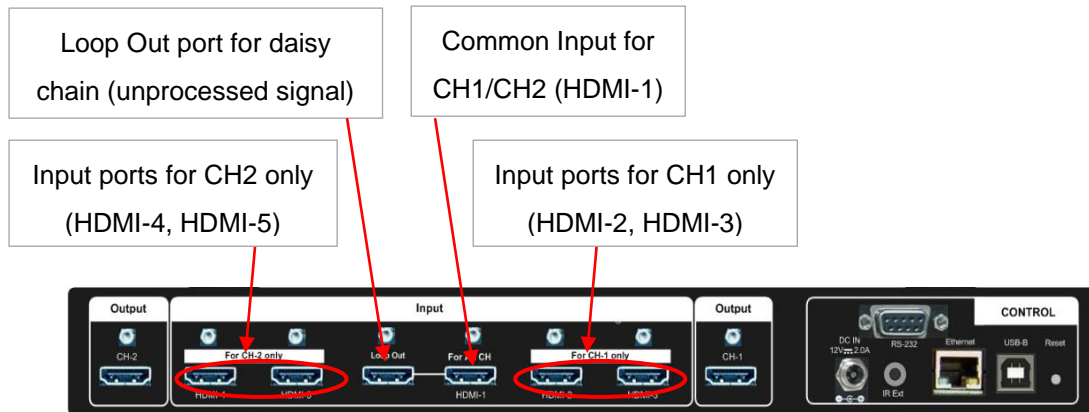

- G902 consists of two processing channels.
- Each channel has independent input/output resolution and video wall settings.
- User can select different contents for each output channel.
- G902 can support non-VESA standard input timings. The input resolution can be up to 4096x2160 @60 Hz and 8k/2k @30Hz.
- Support High Dynamic Range (HDR): SMPTE ST-2084, SMPTE ST-2086 and BT.2020 HDR 10 input signal processing.
- HDMI-1 is common input port to share the same input signal for CH1 and CH2.
- Only HDMI-1 input signals can be looped out. Loop out signal is unprocessed signal. User can cascade multiple units of GeoBox through Loop out port daisy chain connection. In normal condition, it can be connected up to 10 units of G902. The maximum connection unit is related to HDMI cable quality and signal source resolution.
- Each processing channel has three HDMI 2.0 input ports—one is common input to share with other channel and other two exclusive inputs for specific channel only. These two exclusive inputs can't be shared with another channel. User can select two input signals from three input ports to implement PIP/POP application.
- User can implement PIP/POP in one channel and connect the output to the input port in another channel to achieve multi-viewer function. Please see more details in MultiViewer application.
- G902 doesn't have matrix switcher function. If independent content display is required, user needs to arrange the output connection and let input source be displayed at specific monitor.
- User can select input source through remote controller, WebGui or GCT PC tool. Each channel needs to do input selection separately. Default input is HDMI-1 which is shared to CH1 & CH2.

## 6. Output signal and output port configuration

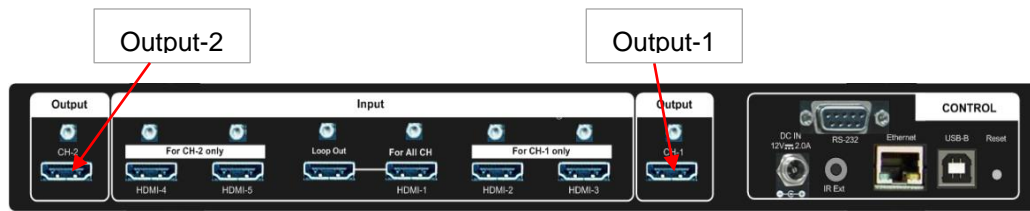

- Programmable Output: 1x HDMI 2.0b up to 4096\*2267 @60fps or 7680\*1234 @60fps, 4:4:4 10-bits, progressive RGB. The output range is from 800-4096 in horizontal (8 Px/step under 230Mhz, 16 Px/step above 230Mhz) and 600-3840 (with 1 pixel/step) in vertical directions (maximum pixel rate is 600 MHz).
- Preset 17 output timing modes with 8-bit/10-bit color mode and 24/30/50/60/100/120Hz selectable refresh rate, including frame rate conversion.
- All output default output is FHD with 60Hz refresh rate, full color RGB 4:4:4 and progressive. If the output resolution is set at 4k/2k, full HD monitor will not show any image. Please click [1080] key on the remote controller to set the output to 1080p.
- If the output refresh rate is not the same as input refresh rate. The frame lock function will be disabled and it may lose synchronization among output channels.
- User can click [Info] key to get system information and input / output signal resolution.

## 7. Typical system connection

Below is typical system connection for 2x1 video wall. Source signal must be connected to HDMI-1. The connection sequence can be random. It can be assigned by Video Wall PAN function.

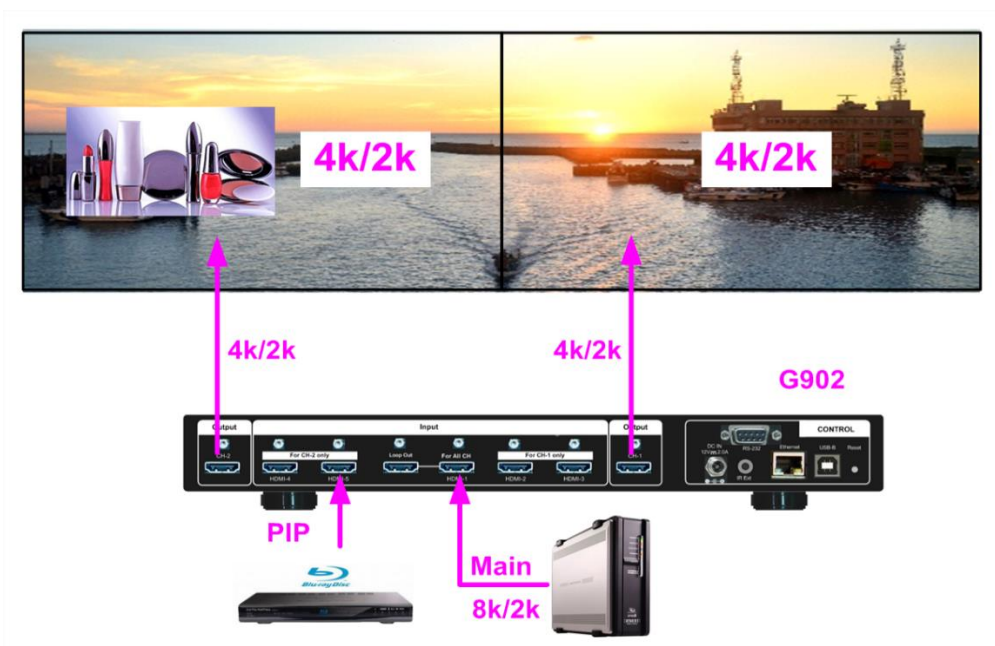

## 8. Select input port

### 8.1. Select input port from OSD

- Select Channel #.
- Open OSD → [Image properties] → [Input Signal] → select input port
- Default is HDMI-1 for CH1 & CH2
- Each channel can select signals from specific input ports independently.



### 8.2. Select input port from remote controller

- Step 1: Select Channel No.
- Step 2: Direct click input selection key. The 1<sup>st</sup> key is default common input key.

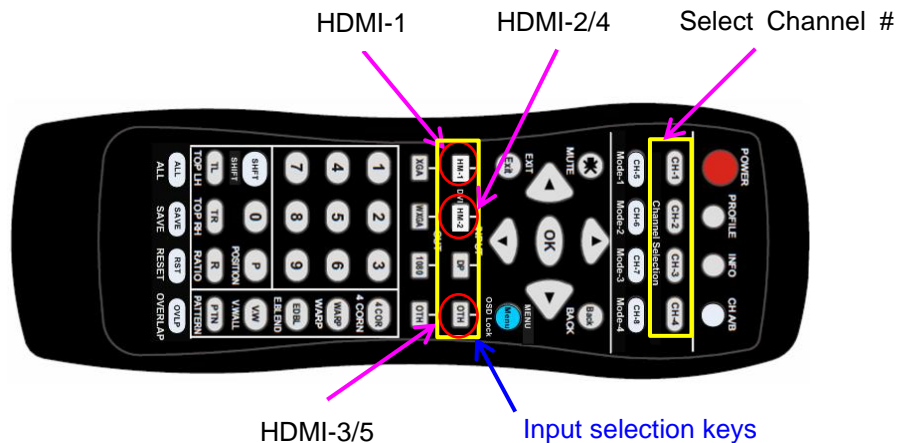

## 9. Set output resolution and signal type

- If G902 output is the same as display device native resolution, it will perform the best video quality.
- Please note that if the output is 4k/2k and connect to FHD monitor, it will not show up the image.  
Please click [1080] output in remote controller to see the image.

### 9.1. Select output resolution from remote controller

Four output resolutions are preset in remote controller--1080P, WXGA, XGA and [OTH] (4k/2k) progressive output with 60Hz refresh rate.

Step 1: select channel No.

Step 2: Direct click Output selection key

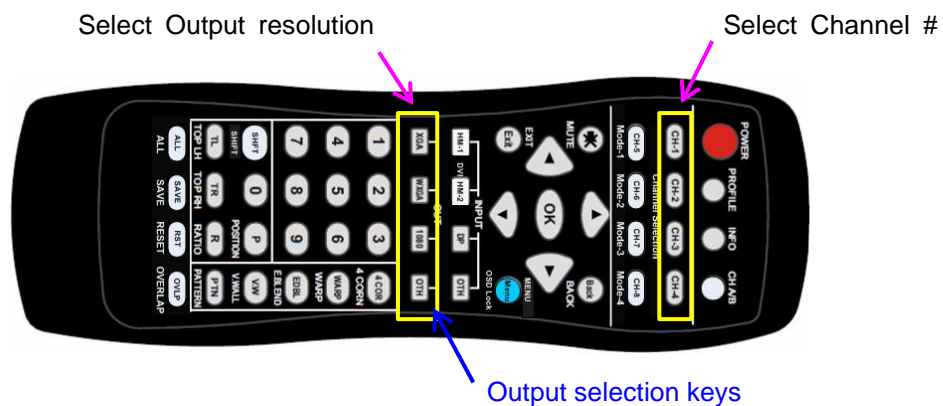

### 9.2. Select output resolution from OSD

- Each channel needs to set output resolution separately. Default output resolution is 1920\*1080/60.
- Select channel No → Open OSD via remote controller → [Image Properties] → [Output] → Select [Output resolution].
- 17 preset output modes are embedded in OSD.
- All default output resolution is FHD 60Hz, RGB 4:4:4 format and progressive.
- If user select a timing that the monitor can't support, user can't see any image,
- If the input refresh rate is not the same as output, it is possible to see synchronization issue among multiple displays.

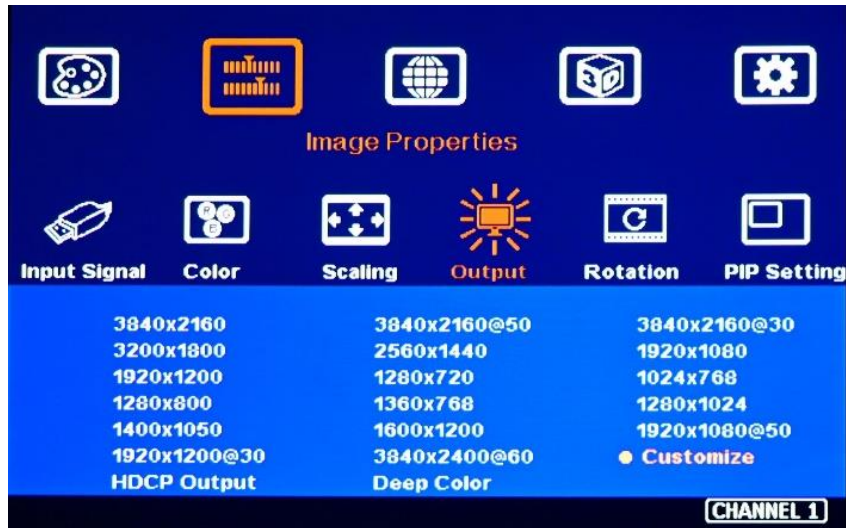

### 9.3. Programmable output resolution

- Programmable output resolution is embedded in G902. User can activate OSD [Image Properties]→ [Output]→ Customize]→ [Width] / [Height]
- The range is from 800-7680 (8 Px/step under 230Mhz, 16 Px/step above 230Mhz) in horizontal and 600-3840 (1 pixel/step) in vertical directions (maximum pixel rate is 600 MHz).
- Customized output resolution is reduced blanking signal. User can check the max. output resolution in different refresh rate from [Customize] OSD.

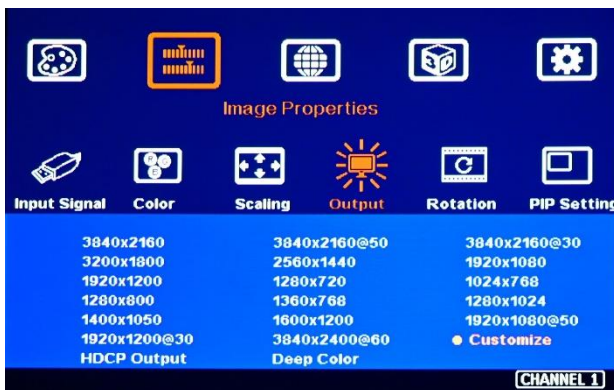

User may not see the image in Full HD monitor when the output resolution is set at 4k/2k. In this case, please click [1080p] key in remote controller to let G902 output at full HD. The output setting in each channel can be set independently. Default resolution is Full HD.

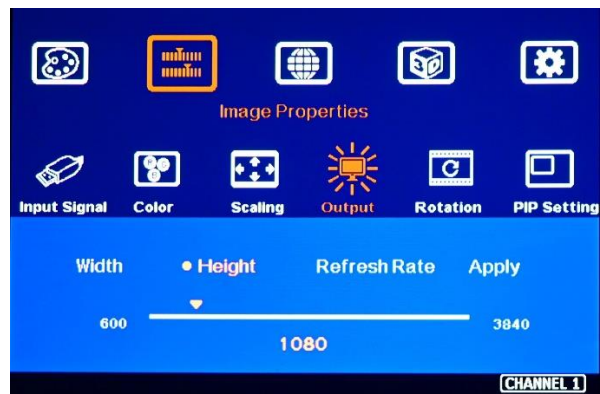
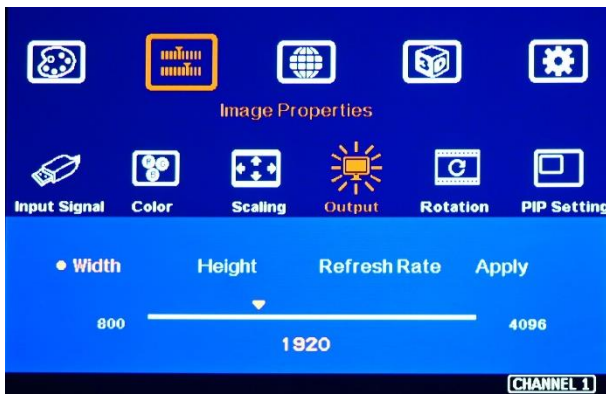

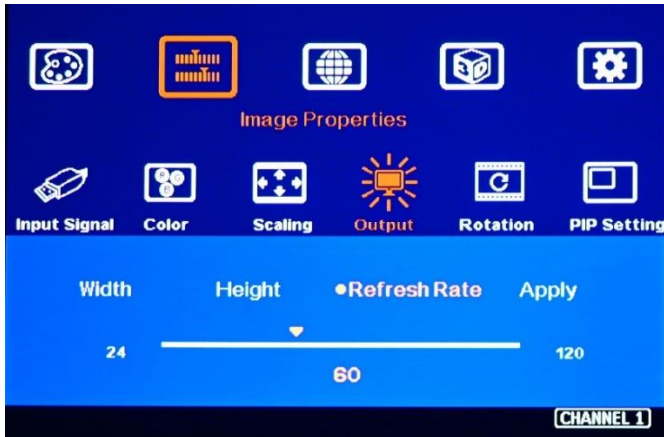

- The output refresh rate can be selected from 24/30/50/60/100/120 Hz.
- If the input and output refresh rate is not the same, it is possible to cause synchronization issues in different output channels.

#### 9.4. Enable 10-bit deep color output

- User can select 10-bit deep color output mode through OSD [Image Properties]→ [ Output Mode]→ [Deep Color]→ On
- User can check the result through [INFO] hotkey on remote controller to understand input/output signal status.
- Enable 10-bit color may reduce the input and output maximum resolution. HDMI 2.0 maximum is 600 MHz (18Gb/s). 10-bits 4:2:0 HDR 4k/2k 60Hz output signal can be supported by G900.

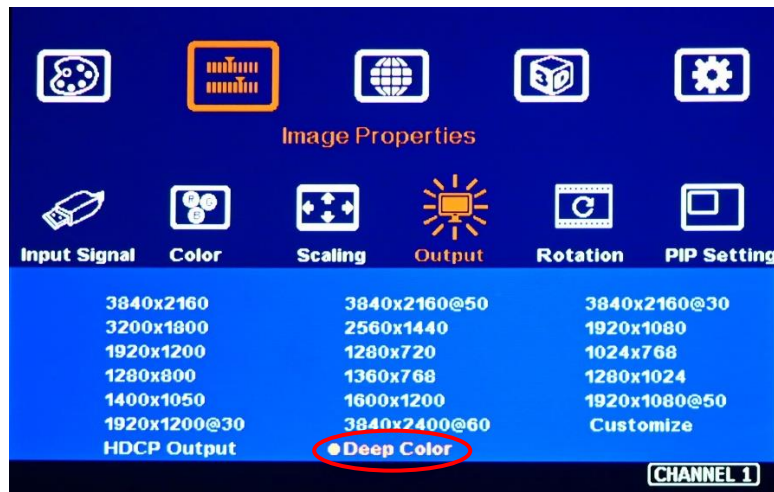

#### 9.5. HDR (BT.2020) processing

- G900 can process HDR input signal and output full color range RGB 4:4:4 progressive signal up to 4096\*2160 @60Hz.
- If the system detects HDR input signal, it will automatically process HDR signal. User can check System Information through INFO key in remote controller to confirm the status.

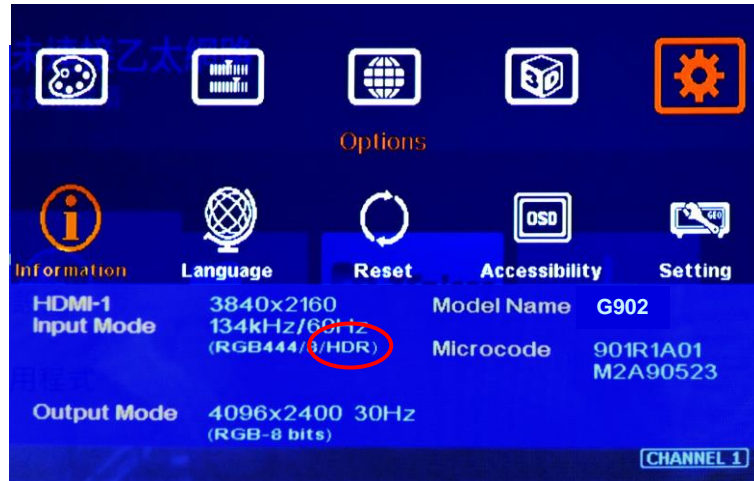

### 10. How to check system information

- The picture showed in below is the system information in each channel. Each channel is independent.
- The content showed in System Information will include below items:
  - Input and output resolution
  - Color depth and HDR status
  - Model No.
  - FW and MCU code version
  - PIP/POP input signal status (If PIP/POP is enabled)

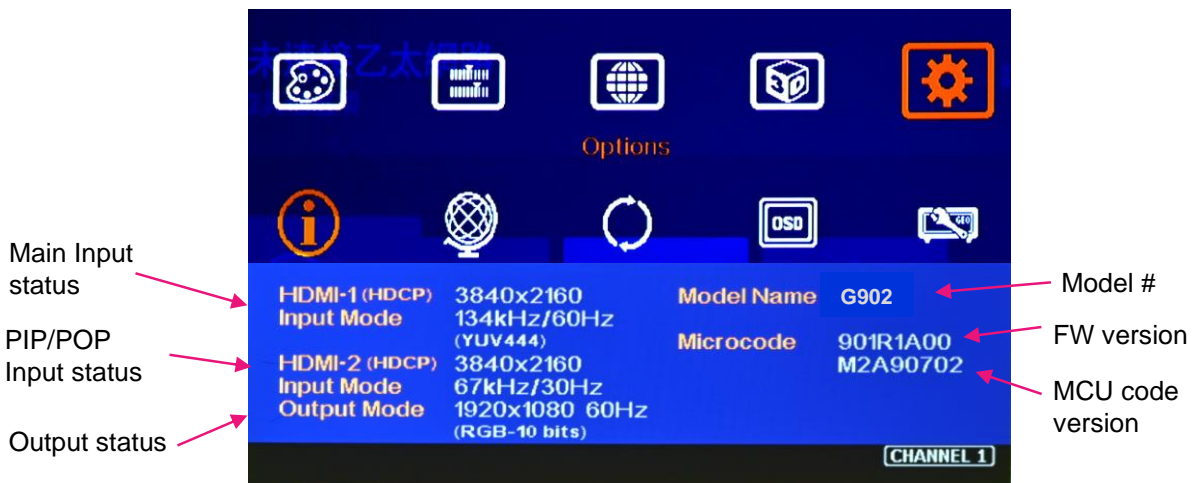

#### 10.1. Check by OSD menu

- Step 1: Select Channel No.
- Step 2: Open OSD Menu → [Options] → [Information]



Please see the result in previous section.

## 10.2. Check by remote controller

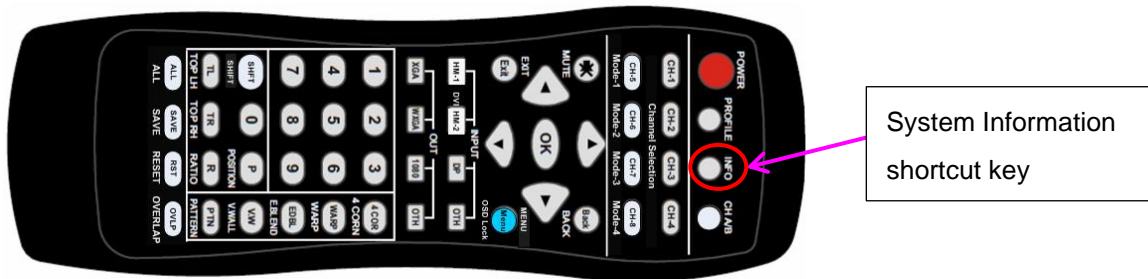

## 11. System control and setup

- The setting for Box ID, RS232 and Ethernet can be executed via OSD, WebGui or GCT PC Tool. User can change Box ID, RS232 and Ethernet through CH-1 OSD, WebGui or GCT PC Tool.
- User can control G900 directly from Ethernet. The default static IP address is 192.168.0.100.
- User can set different IP address or Box ID for each unit so that user can execute independent control to each GeoBox without interference.

### 11.1. Box ID (can be changed through CH-1 OSD)

- Box ID is required for the application with multiple units of GeoBox.
- Box ID range is from #1 - #99. When user uses remote controller to control the system through OSD, the maximum ID setting for remote controller is #1 - #9.
- Please set Box ID through CH-1: OSD [Options]→ [Setting]→ Box ID]→ select number.

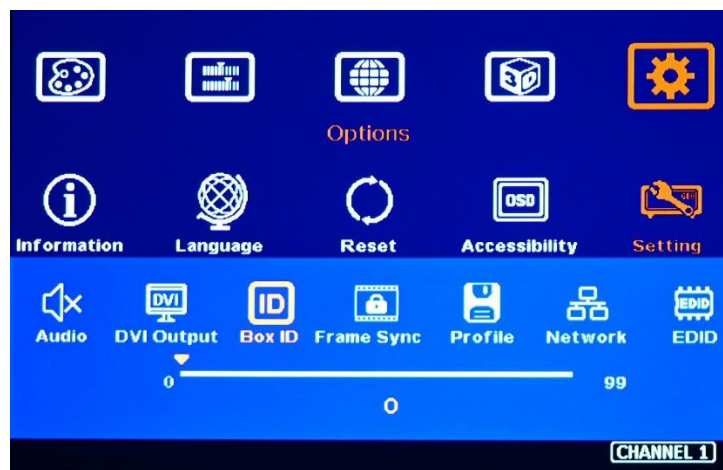

## 11.2. Multiple units controlled by one Remote Controller

- When multiple units are used and all boxes or IR extender receivers are installed together, user can control individual unit through below method:
  - To Press 851 number keys on remote controller, then all the following operations in remote controller will take effect only in ID #1 GeoBox and lock all other GeoBox. User can see flashing LED on the Front Panel of the locked units.
  - To Press 853 will only unlock ID # 3 GeoBox for further OSD operation.
  - To press 850 will unlock all GeoBox OSD menu. Remote controller can access to all GeoBox simultaneously.
- The OSD in the unit with flashing LED was locked by remote controller 85x command. The flashing time interval is 1.0 second. User can press 850 number keys to unlock the OSD.

## 11.3. RS232 Setting

- RS232 interface is designed with DB-9 connector. User can select 11520 or 9600 baud rate.
- The UART Protocol between GeoBox and a Host computer can be provided. The protocol can be executed via RS-232, USB, Ethernet or other forthcoming communication methods.
- Please execute RS232 setting through CH-1 OSD, WebGui or GCT.

## 11.4. Ethernet setting



- User needs to connect G900 to WiFi Router or switch/hub through RJ45 to LAN port. Then user can control the system through Ethernet.
- UTP cable can be used for direct connection between PC and GeoBox. User needs to set PC TCP/IPv4 with the same domain segment as GeoBox (for instance, to set IP address at (192.168.0.105) and subnet mask at (255.255.255.0)).

- Open web browser (Google Chrome or Internet Explorer) and input G902 IP address (default is 192.168.0.100), user can see GeoBox WebGui and menu with virtual keys similar to OSD for further system operation. There is no additional software is required.
- If user can't connect the network, please power off/on G902 again to let PC detect G902 network.
- User can set DHCP for the connection. If necessary, please [Renew] DHCP to get IP address before network connection.
- GCT PC Tool is another web tool that has full function for system setting and operation. It can also update Firmware or MCU code. GCT can be downloaded from VNS website.
- Each G902 can set different IP address for independent operation and control.
- Please use < > OSD keys to select OSD menu items and use ^ v OSD keys to change IP address.
- If G902 is connected with WiFi Router (through LAN port), user can control G902 through WiFi via PC, iPad or mobile phone.
- Default TCP server port is 1266.
- User can change IP address through CH-1 OSD, WebGui or GCT PC tool.
- [GeoBox IP-TCP application note] is available at <https://drive.google.com/file/d/1iw3mgLmqzsJ8m1KYarYasZbGlvp0vtK7/view>

## 12. PIP/POP multiple image display

### 12.1. PIP/POP main menu

#### 12.1.1. [Display]

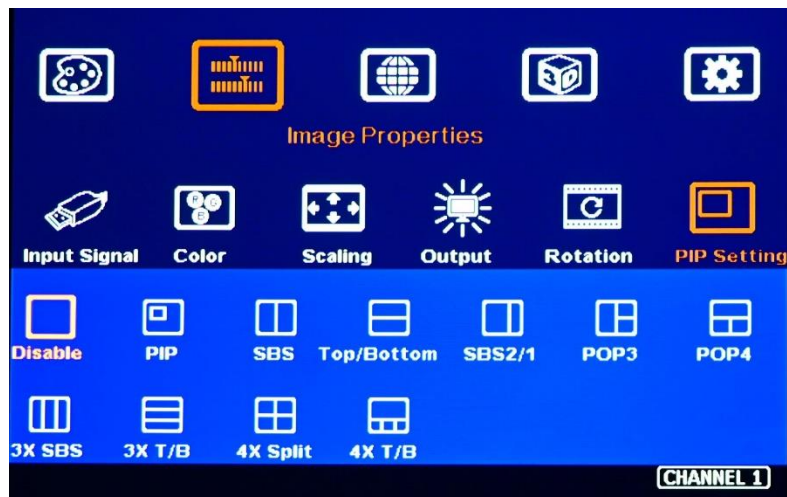

- [Disable]: Disable PIP/POP display.
- [[SBS]: Side by Side display.
- [Top/Bottom]: Top/Bottom display.
- [SBS 2/1]: 2/3:1/3 side by side display with monitor at landscape position
- [POP3]: One image at LH side and two top/bottom images at RH side in landscape monitor.
- [POP4]: One image at Top and two images at bottom in landscape monitor.
- [3X SBS]: Three split views at landscape. The center image size is adjustable.
- [3X T/B]: Three split views at portrait with full screen or original aspect ratio selection.
- [4x Split]: Four split view multi-viewer. (Monitor at landscape only. User needs to implement through two channels to get this function due to only 3 inputs in each channel)
- [4x T/B]: Four split view with one image at top and three small images at bottom. (Monitor at landscape only. User needs to implement through two channels to get this function due to only 3 inputs in each channel)
- PIP (picture in picture): with flexible PIP size (320\*180 to 1920\*1200), location and ratio.
- PIP main and sub-window can be seamless quick swap under FHD in/out with full screen display.
- Except [4x split] & [4x T/B] functions, all the other PIP/POP functions can support monitor at portrait and landscape position. Sub- images also support rotation and flip up to 4k/2k 60Hz.
- Cropping function is available in PIP and POP image for further location, size and aspect ratio adjustment as well as creating image borders with black or blue color.
- All the inputs for main and sub-images can be up to 4k/2k 60Hz 4:4:4 signals.

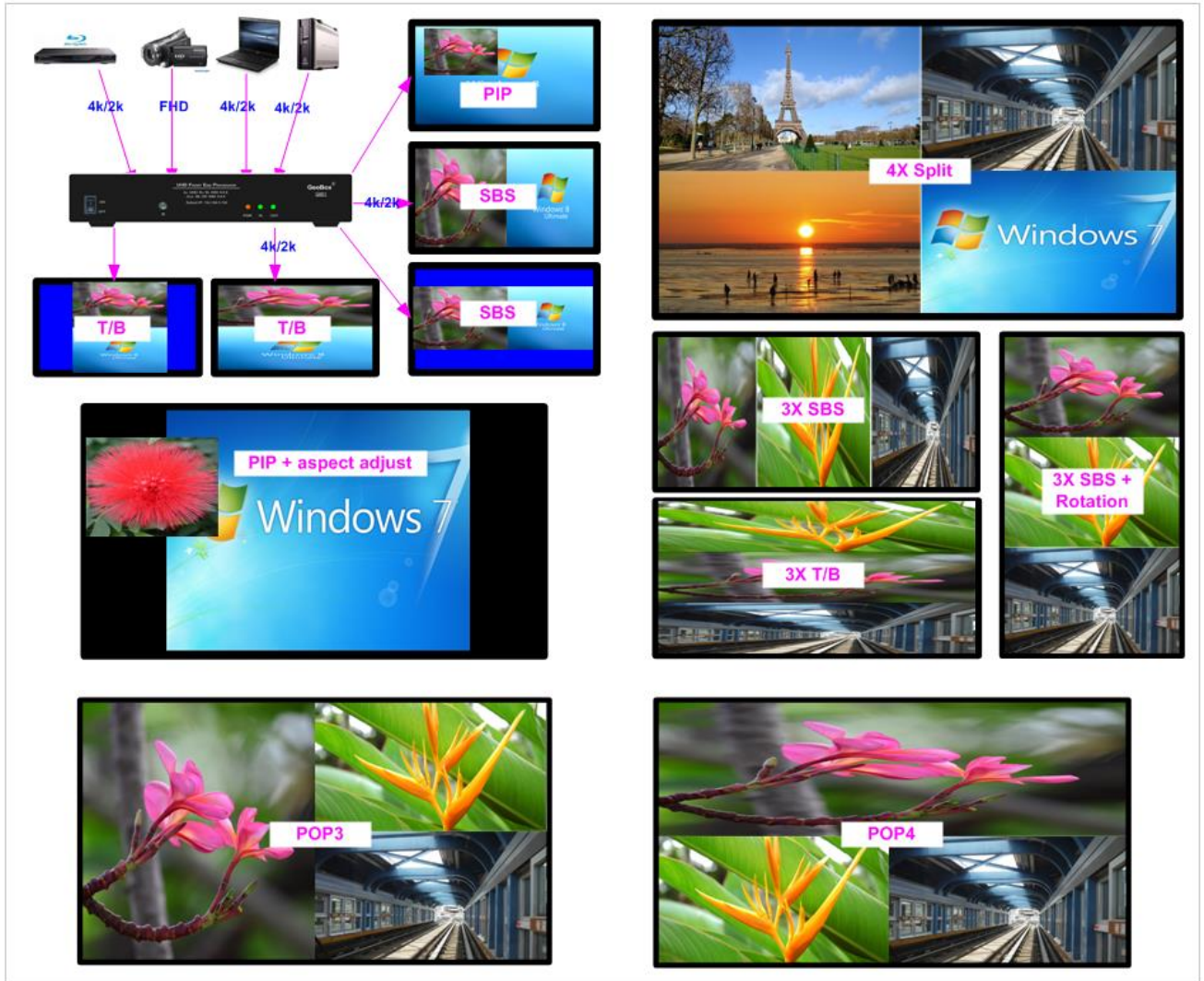

**12.1.2. PIP/POP source selection**

- The input source for main and sub-images can be selected separately without limitation.
- Any signal from input ports can be displayed on PIP/POP screen up to 4k/2k 60Hz.
- User can swap the position in Main and sub-image--to select main image from [Image Properties]→ [Input Signal] Menu and select PIP image from [Image Properties]→ [PIP Setting]→ [Source]→ [SubWin1-3].
- User can save different settings into [Profile] under [Options] menu and recall at any time.
- Any input port can be selected as main or sub-image input source.

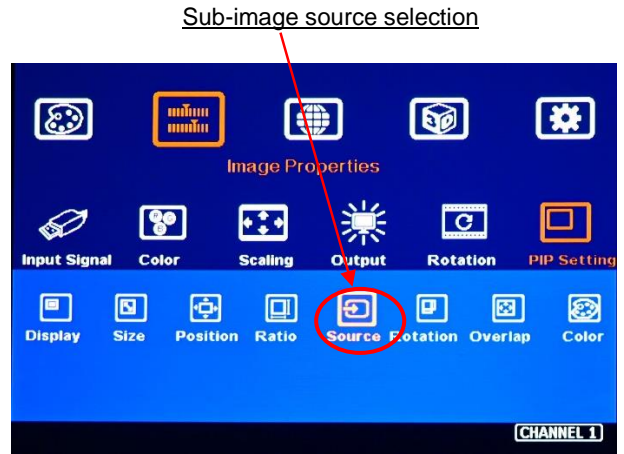
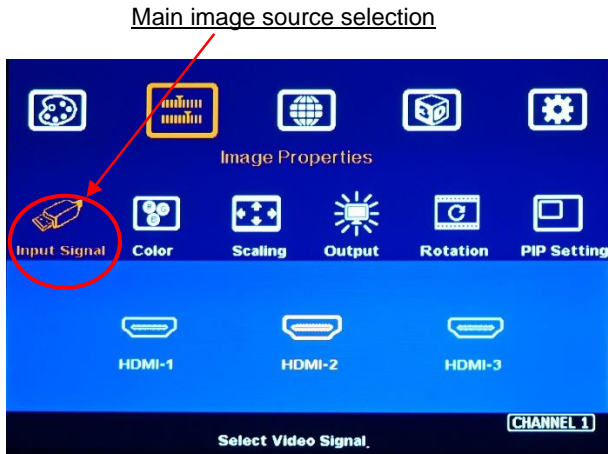

### 12.1.3. PIP/POP image rotation

- Main and sub-images can be rotated separately at 90/180/270 degrees based on the installation direction of the monitor.
- Main image rotation shall be selected from [Orientation] under [Image Properties] OSD.
- Sub-image rotation must be operated through [Orientation] under [PIP Setting] OSD menu.

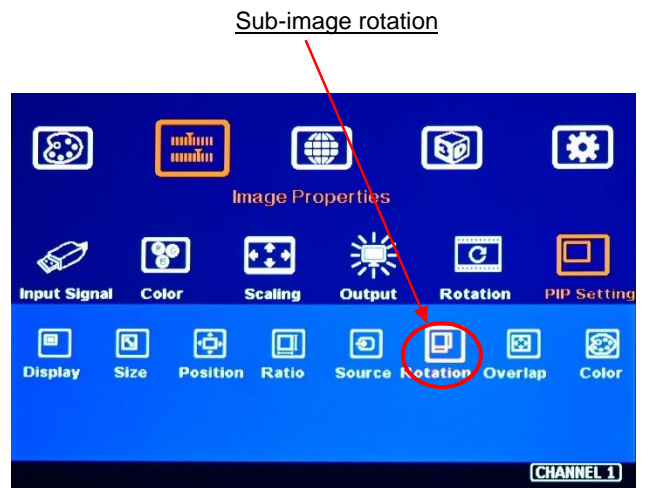
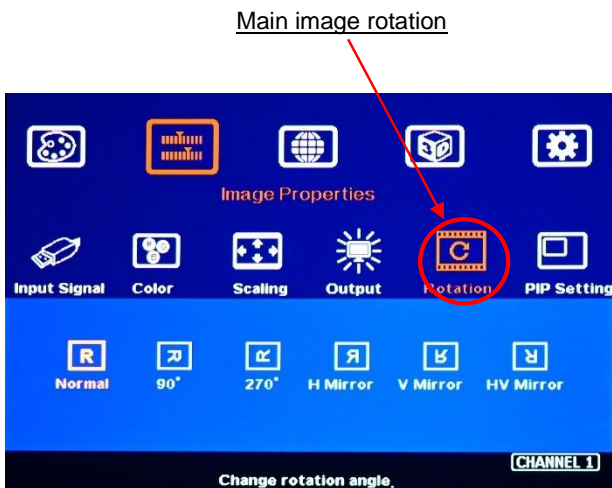

**12.1.4. Maintain original aspect ratio or follow output aspect ratio**

- Main Image: can be selected through [Scaling] OSD menu under [Image Properties].
- Sub-Image: can be selected through [Ratio] OSD menu under [PIP Settings].
- Under aspect ratio menu, there are two selections: [Full Screen] & [Original AR]
  - Full Screen: to display full screen image in PIP or POP.
  - Original AR: keep aspect ratio same as signal source in PIP and POP.

Main image ratio selection

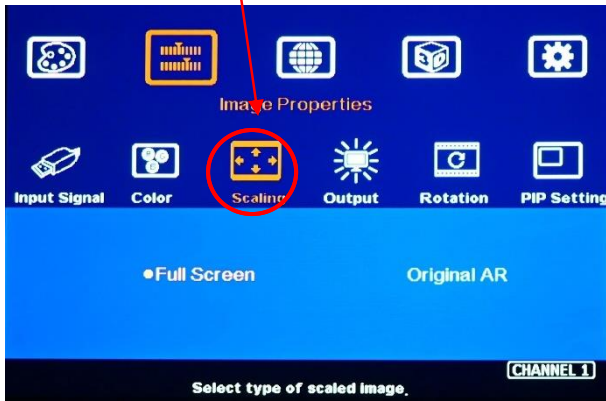

Sub-image ratio selection

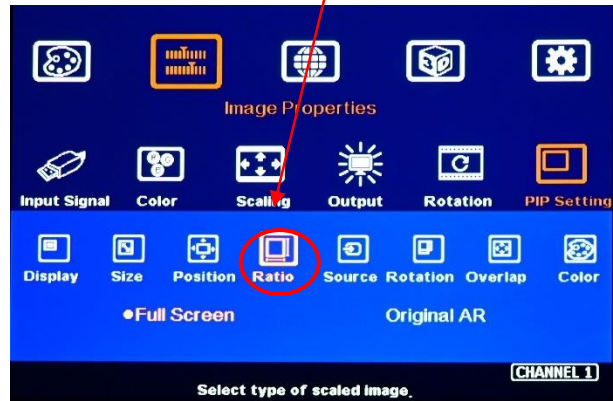

**12.1.5. Adjust aspect ratio or cropping area in main and sub-image**

- User can change the cropping area and aspect ratio in main and sub-image images through Overlap OSD menu. Each edge can adjust the overlap up to +\_1800 pixels.
- When Overlap value is decreased, the image cropping area will be reduced and cause the image have Zoom-In effect (enlarged). If the Overlap value is increased, the image cropping area will increase and cause the image to have Zoom-out effect (shrunk).

Main image Overlap adjustment

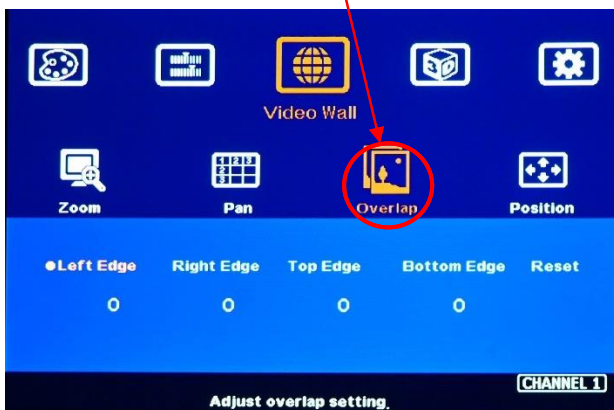

Sub-image Overlap adjustment

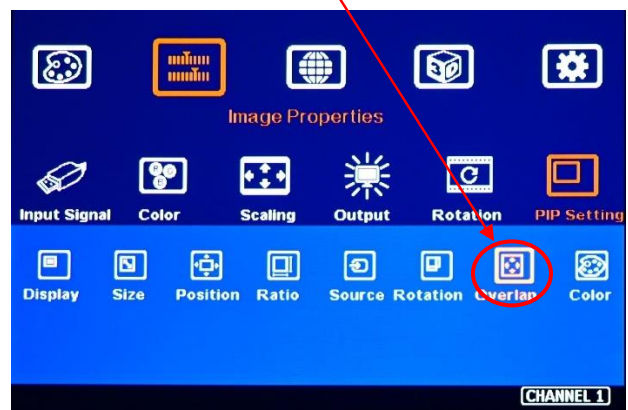

## 12.2. **PIP (Picture in Picture)**

- Flexible position across entire screen.
- PIP image size and aspect ratio can be adjusted through [Overlap] function
- PIP main and sub-window can be seamless quick swap under FHD in/out with full screen display.
- PIP and main images can be rotated at 90/180/270 degrees to build different display styles. If one PIP image across multiple monitors (video wall) is required, user can feed PIP image to all channels and use [Size], [Position] & [Overlap] functions to get one PIP image across entire video wall. User can also add one G900 as front end to have more flexible PIP/POP.

### 12.2.1. **PIP [Size] and [Position]**

- PIP image size is from 320\*180 to 1920\*1200
- It can be further adjusted through Overlap function to get about 160\*130 image size.
- User can replace main image with sub-image on entire display under FHD output resolution.
- The PIP image position can be at any location with 100 adjustment steps in H&V direction.
- PIP image in each channel is independent.

## 12.3. **POP (or PBP): Picture outside Picture (or Picture by Picture)**

- [SBS]: Side by Side 2 split display.
- [Top/Bottom]: Top/Bottom 2 split display.
- [SBS 2/1]: 2/3:1/3 side by side display.
- [POP3]: One image at LH side and top/bottom two images at RH side.
- [POP4]: One image at Top and two images at bottom.
- [3X SBS]: Three split views at landscape. The center image size is adjustable.
- [3X T/B]: Three split views at portrait direction.
- [4x Split]: Four split view multi-viewer. (Monitor at landscape only)
- [4x T/B]: Display 4 split views with one image at the top and 3 images at the bottom. Below 3 windows keep 16:9 aspect ratio. Main image can keep full screen or original aspect ratio.
- POP function is independent in each channel. One G902 can display 4 contents in one 4k monitor.

### 12.3.1. **Aspect ratio adjustment**

- POP image aspect ratio selection:
  - ✓ Main Image: can be selected through [Scaling] under [Image Properties].
  - ✓ Sub-Image: can be selected through [Ratio] OSD menu under [PIP Settings].
- Further aspect ratio adjustment can be executed through Overlap function. Please see more details in [Overlap] section.



**Independent aspect ratio in main and sub-images**

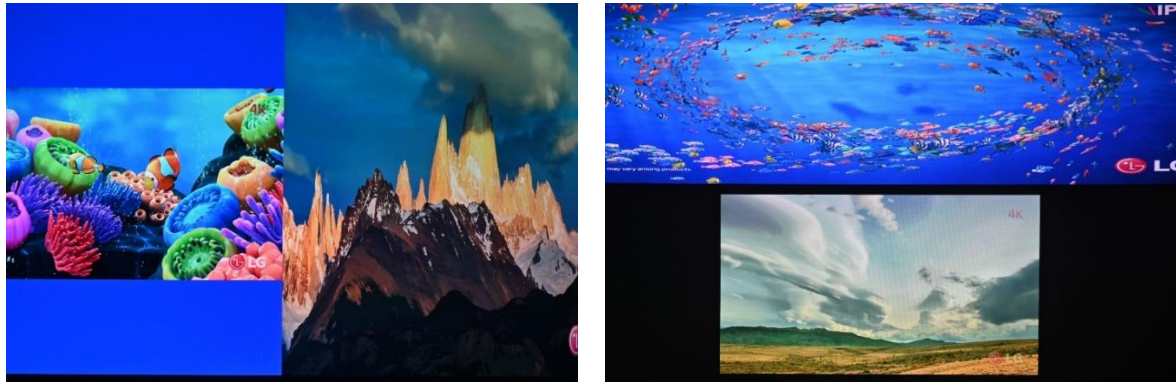

**12.3.2. [Orientation]**

- Image rotation in main and sub-image can be executed separately.
- Image rotation can be executed together with image cropping and aspect ratio adjustment functions to create more display styles.

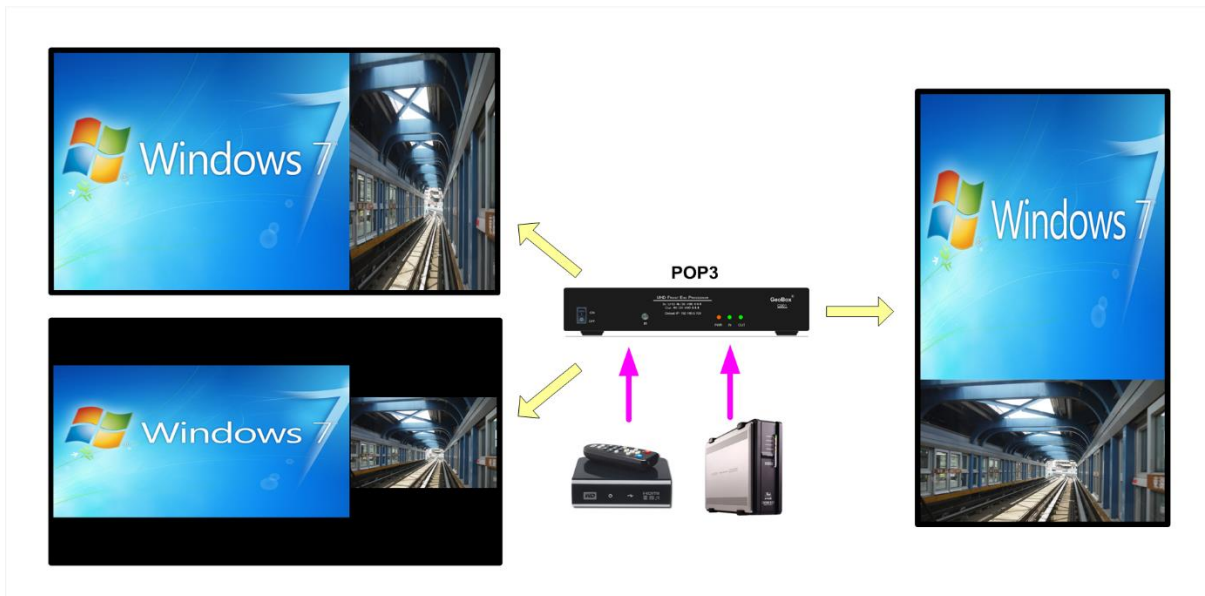

**12.3.3. [Overlap]**

- Overlap function under [PIP Settings] will only be functional for sub-image. The function is the same as [Overlap] function under [Video Wall] for main image.
- It can change sub-image position, size and cropping area pixel by pixel.
- Through Overlap function, main image and sub-image can be displayed with various size and aspect ratio as show below.

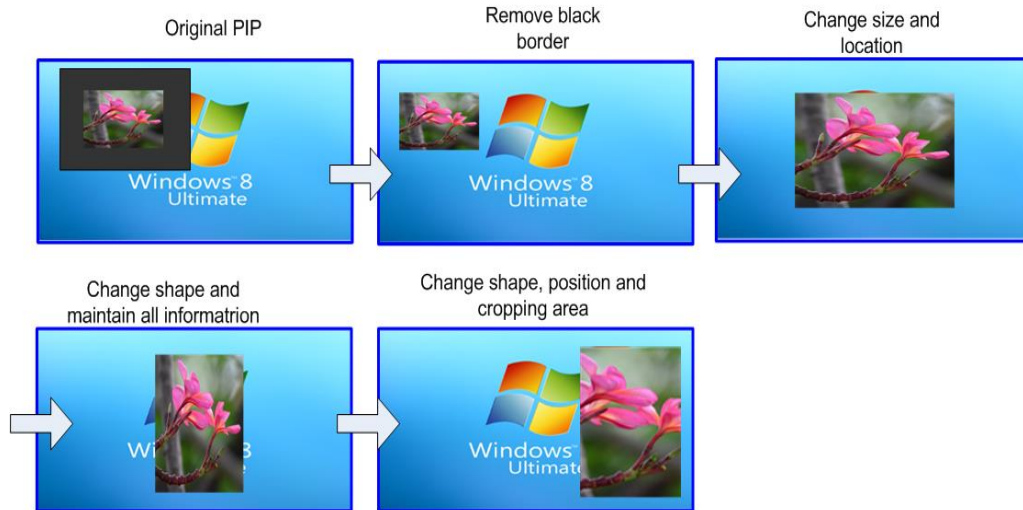

- User can feed the PIP image to each channel and apply [Size], [Position] and [Overlap] to achieve one PIP image across entire video wall.

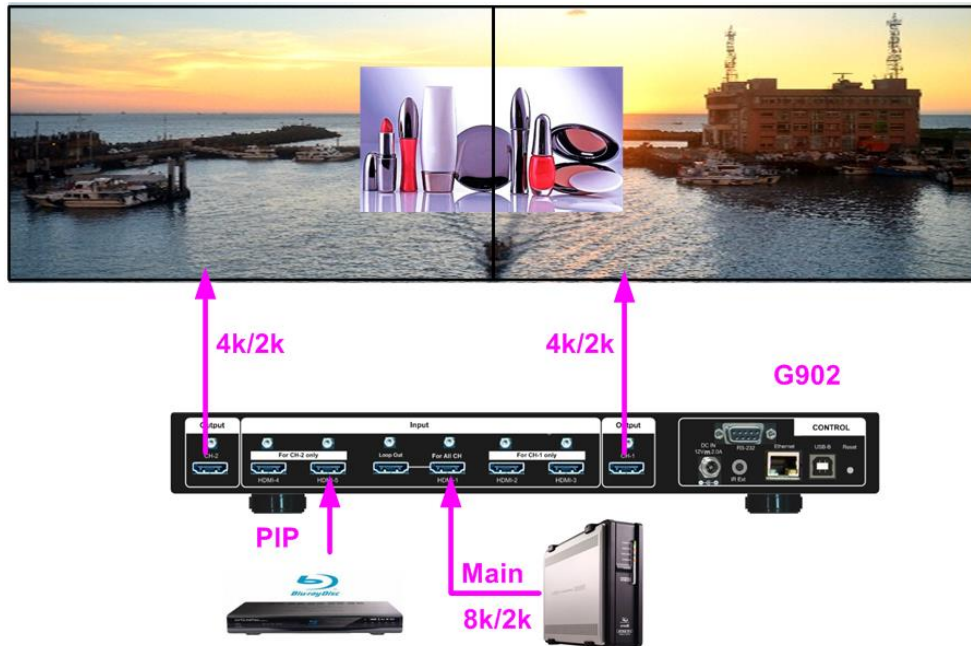

### 13. Quick PIP ON/OFF and two inputs quick seamless swap

- CH A/B key in remote controller can execute quick PIP image on/off switching in each channel.

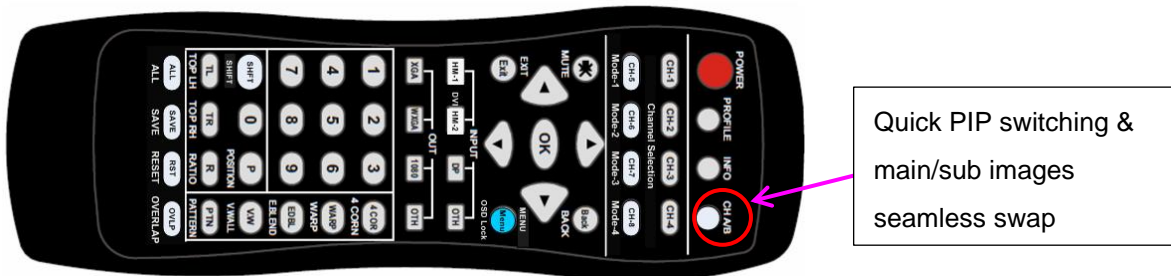

- When the output resolution is set to 1920x1200 or 1920x1080, user can add full screen PIP image on top of main image. User can click [CH A/B] key to turn on/off PIP image to swap main/sub-images seamlessly.
- This image swap can be applied to any two inputs in each channel. Please select channel selection key and assign one input to main image and another input to PIP image, then click [CH A/B] key to execute seamless quick swap between these two inputs.



## 14. Advanced functions

### 14.1. Image rotation and flip

- ✓ There are two image Orientation OSD menu. One for main input and the second is for second input for PIP/POP.
- ✓ Image can be rotated at 90/180/270 degrees and flipped at Right/Left, Top/Bottom or Front/Rear. This function can support up to 4k/60Hz input signal.
- ✓ Image 90/270 degrees rotation is for video wall with monitor installed at portrait position. There is no need to rotate signal source.
- ✓ When main image is rotated or flipped, the OSD will be rotated together with main image.
- ✓ User can see the direction of the TEXT “R” to do image flip and rotation.
- ✓ Main image and PIP image can be rotated independently.

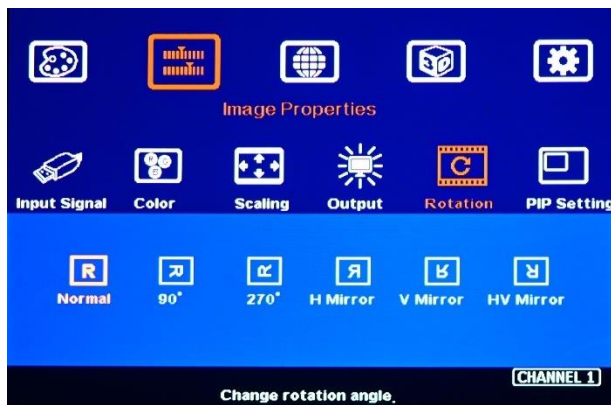

Rotation for main input

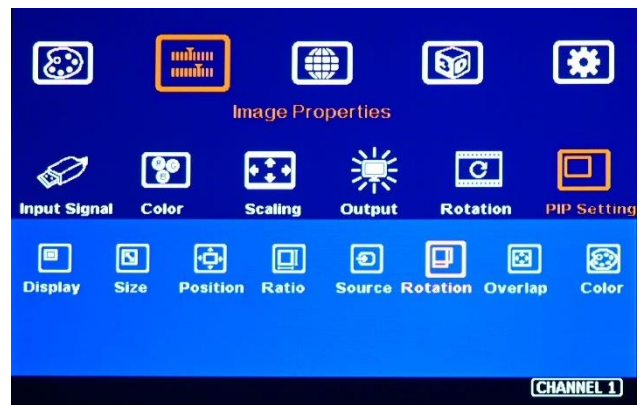
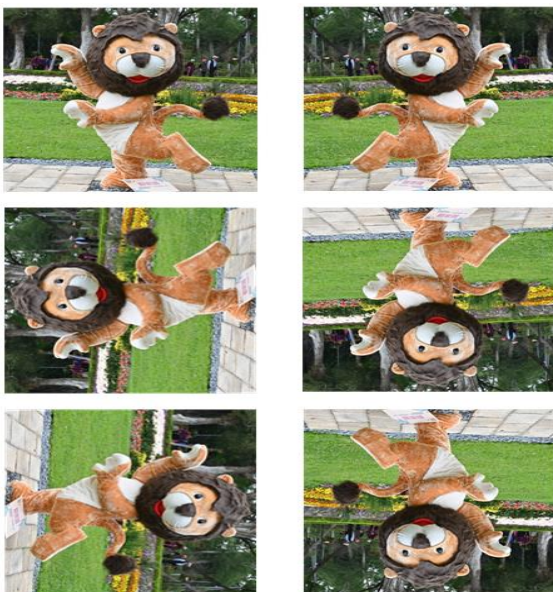

Rotation & cropping for sub-input (PIP)

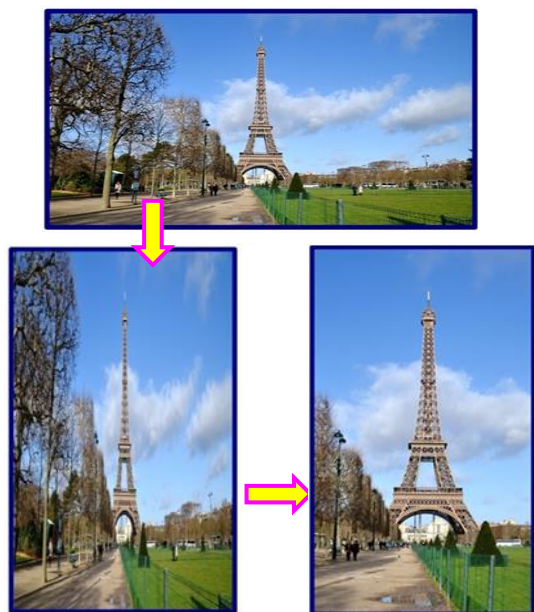

### 14.2. Image Cropping in main and PIP/POP (Sub-images)

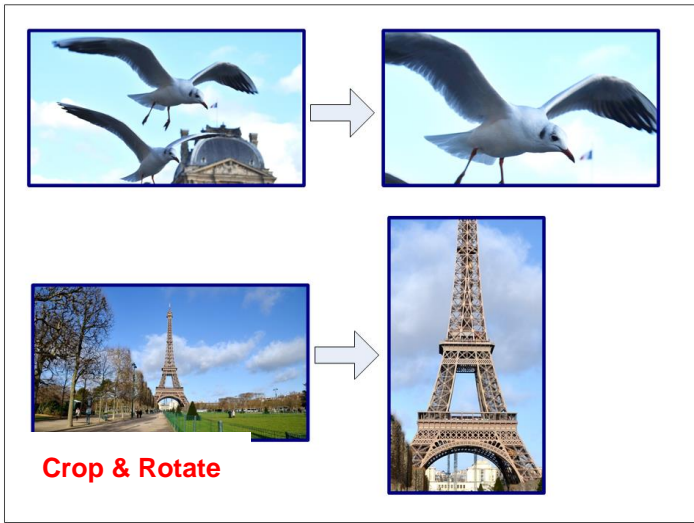

- ✓ Image cropping in both main and PIP/POP (sub-image) can be done separately.
- ✓ [Video Wall] setting is for main image cropping.
- ✓ [Overlap] setting under [PIP setting] menu is for sub-image cropping.
- ✓ Image cropping function can co-exist with image rotation and flip functions.

### 14.3. Flexible Aspect Ratio Adjustment

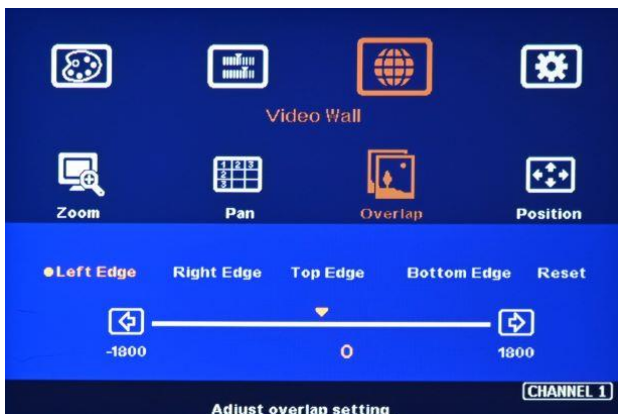

User can use Video Wall [Overlap] function to change the aspect ratio of the image with black or Blue borders or to stretch the image in specific direction to compensate the aspect ratio difference between video wall and the content. The Maximum adjustment range is +\_1800 pixels in each edge.



Background color can be black or Blue color.

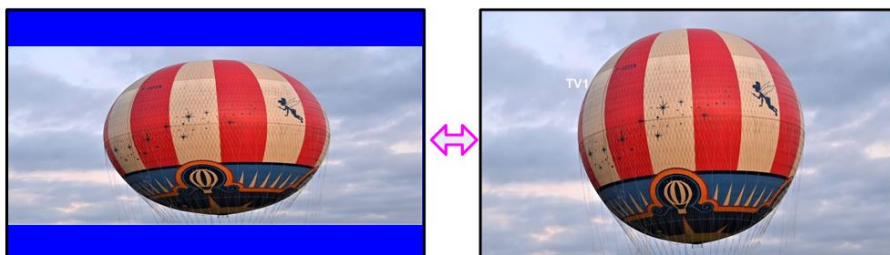

**Case Study: Aspect ratio calculation**

Below is case study regarding the relation between aspect ratio and overlap value settings in Video Wall. If LH edge Overlap value increase 300 pixels and RH edge increases 400 pixels on FHD image, it means the video total horizontal pixels will increase 400+300=700 pixels. As a result, the total horizontal active pixels will be 1920+700=2620. The original image in horizontal direction will become  $1920/2620=73.28\%$ . The final aspect ratio will become  $(16*73.28):9=11.7:9$



**14.4. System Standby and automatically turn off output signal**

- ✓ OSD [Options] → [Accessibility] → [Standby Time]
- ✓ If set [Standby Time] at 60, the system will get into Standby Mode after 60 seconds when no input signal is detected. The output signals from G902 will also be terminated at the same time. If G902 detects input signal again, it will automatically turn on the system again. During Standby period, G902 will be still in ON status.
- ✓ If the monitor can automatically turn off/on function by detecting input signal, user can control signal source to execute entire system on/off control.

**14.5. Change Background Color in Blue or Black**



- ✓ OSD [Options] → [Accessibility] → [Black Screen] → [Off]/[On]
- ✓ When no signal input, user can select either blue color background with [Power Saving Mode] message on the screen or black background color without message.

## 14.6. Native 1:1 pixel to pixel image display mode

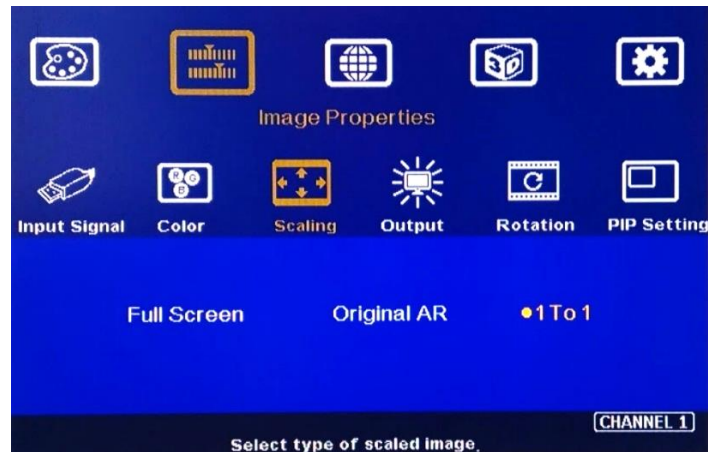

When single content is displayed on the screen, user has below choices for the display:

- [Full screen]: to display the content with full screen. The image will be scaled to full screen no matter the input is with what kind of aspect ratio.
- [Original AR]: to display content with original aspect ratio. If 4:3 input content is displayed on 16:9 monitor, it will keep 4:3 image aspect ratio with vertical full screen on the monitor.
- [1:1]: to display native pixel to pixel image at the center of the screen. When XGA image is displayed on 16:9 monitor, it will show up pixel to pixel XGA image at the center of the monitor without scaling to keep original image quality.
- Further image cropping and aspect ratio adjustment is still available.

## 14.7. Turn off splash screen Logo

- User can turn off splash screen Logo through [Options]→ [Accessibility]→ [Logo Time Out] and set the value at "0". Default setting is 10 seconds.
- It will reduce some boot up time.

## 14.8. Image freeze

User can use [Shift] key in remote controller to execute image freeze. It will be useful while display video image. To press [Shift] key again, it will disable image freeze function.

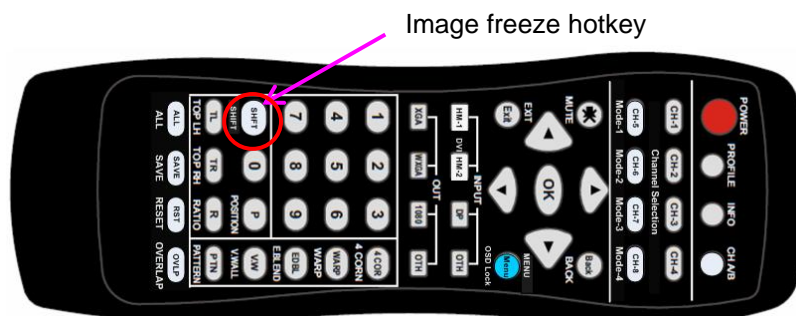

### 14.9. Audio Output setting

If user executes PIP/POP function, user can select the audio source between main and sub-image. Mute function is available. The output sound is embedded inside HDMI output signal. It is only stereo audio. Please access [Option]→ [Setting]→ [Audio Mute] to do audio setting.

### 14.10. HDCP control

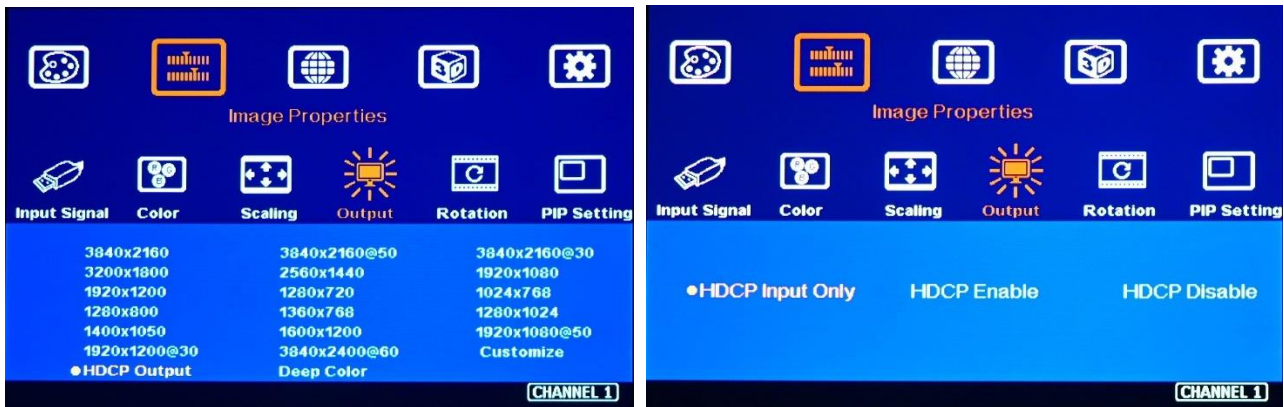

Three sub-menu under [Image Properties]→ [Output]→ [HDCP Output] settings:

- [HDCP Input Only]: Encrypts HDCP only if the input signal has HDCP.
- [HDCP Enable]: Always output HDCP
- [HDCP Disable]: Does not encrypt HDCP. Only non-HDCP compliant input signal can be output.



## 15. Video Wall settings

- G902 can support up to 7680\*2160/30Hz input resolution with 4k/2k/60Hz output resolution in each output port. It is designed for the video wall with UHD monitors.
- G902 is integrated with common input port to be shared with two channels as well as loop out port for daisy chain connection to build big scale video wall. Usually, it can be connected up to 10 steps daisy chain connection from one input signal.
- Besides common input port, each channel has two independent input ports to display independent content in each monitor as well as PIP/POP multiple windows display in one monitor. The maximum input signal source for each channel will be three, including one common input port shared with another channel.
- Signal source shall be connected before video wall settings. The setting parameters inside GeoBox will automatically change according to different input resolution once the setting is finished. If no signal source is connected during video wall setting, it will assume the input resolution is the same as output resolution.
- Press [V. Wall] hotkey on Remote Controller to activate [Video Wall] menu. WebGui and GCT PC tool are available through Ethernet connection. USB can also be used for GCT tool operation.

### 15.1. [Zoom]

Use [Zoom] to split the display in horizontal and vertical directions. GeoBox will split the image into different sections. Maximum split image is 15 in both horizontal and vertical directions.

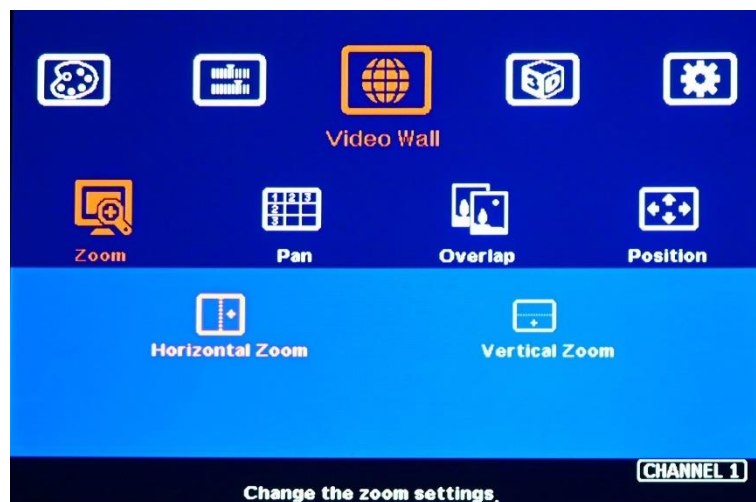



*For 3x1 video wall displays*

*Horizontal Zoom= 3, Vertical Zoom = 1*

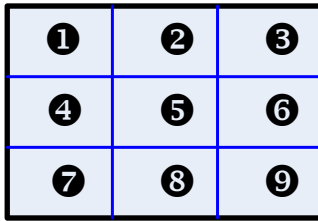

*For 3x3 video wall displays*

*Horizontal Zoom = 3, Vertical Zoom =3*

**15.2. [Pan]**

[Pan] will assign the location of each split image in the display in both horizontal and vertical directions. Horizontal direction is counted from Left to Right and Vertical direction is counted from Top to Bottom.

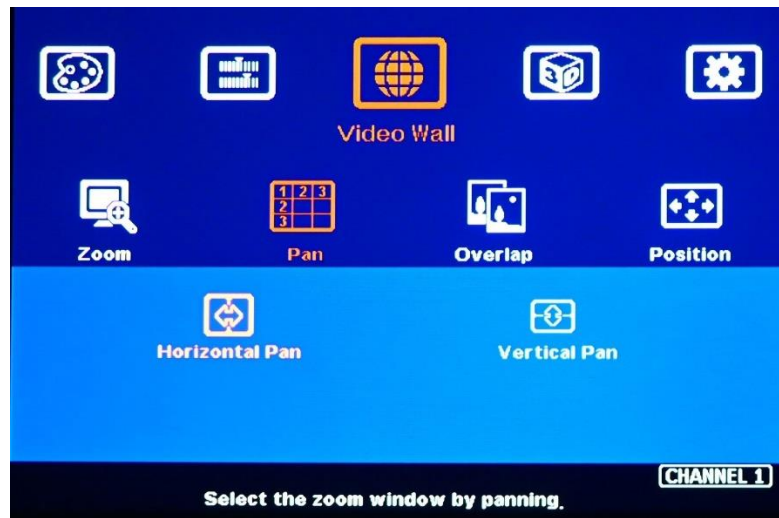

In the case of 3x3 video wall display, Pan settings are as below:



*For No. 3 monitor:*

*Horizontal Pan = 3*

*Vertical Pan = 1*

*For No. 6 monitor:*

*Horizontal Pan = 3*

*Vertical Pan = 2*

### 15.3. [Overlap] – Bezel Compensation and Position Alignment

[Overlap] adjustment changes the cropping area of the image so that image position in each monitor will be shifted. It can compensate Bezel Size of the monitor and correct misalignment in monitor installation. If overlap value is decreased, each monitor will crop less image area and cause [zoom in] (enlarged) effect. If overlap value is increased, each monitor will crop more image area and cause [zoom out] (shrunk) effect. User can also use this function to shift the whole image location for irregular video wall and set overlap area for projector edge blending application.

- Maximum [Overlap] adjustment value is +\_1800 pixels in all directions.
- User can see real time image and select [Edge] to adjust [Overlap] value to do Bezel correction.
- [Overlap] adjustment can also compensate the position mis-alignment in monitor installation.
- User can reduce [Overlap] value to stretch the image outside video wall (some image will be missing) or draw image inside video wall with Black or Blue blanking area at the edge through increase [Overlap] value. This function can adjust the aspect ratio of the content to match required aspect ratio of the video wall. Please see more details in [Flexible Aspect Ratio Adjustment] section.

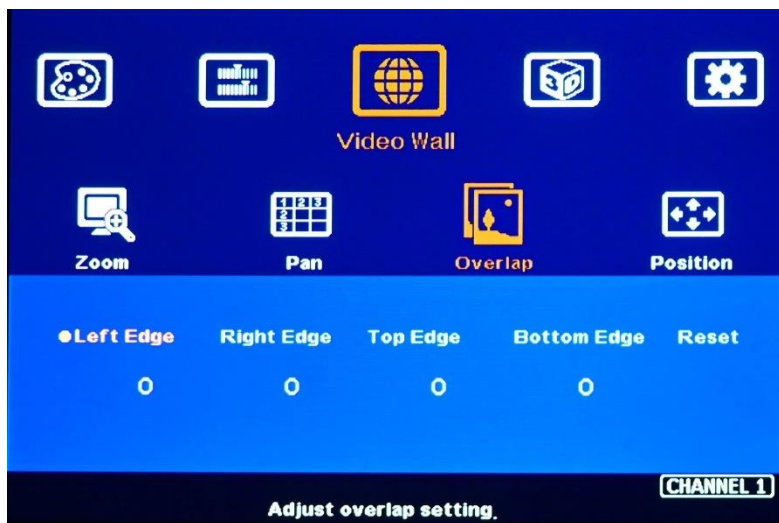

### 15.4. [Position] –Image position adjustment

[Position] function is to shift image position without changing image size or aspect ratio. After activate [Position] menu, user can use direction key to change the image location. It is possible to see blank border after image position shift.

## 16. Passive 3D application and 3D format conversion

### 16.1. Passive 3D System Configuration

G900 can support 3D signal from all kinds of 3D video sources, including Blue Ray DVD, STB, Media player, Game console and PC... 3D signal will be decoded by G900 into signals for Right/Left eyes for passive 3D application or convert into specific 3D format for 3D display devices. The signal for passive 3D needs to be displayed through two projectors. Two projector images need to be stacked on the screen through geometry alignment function in the projector. Each projector will display signal only for one eye. User needs to set a polarized filter in front of the projector and also wears polarized glasses. The glasses need to match the polarized filter in front of the projectors so that the right eye can only see the scene for right eye and the left eye can only see the scene for left eye. Silver coating 3D screen is required to preserve the polarization of the light for 3D display. It is possible to use optic spectrum method from Infitec.net to allow 3D displayed on conventional 2D screen.

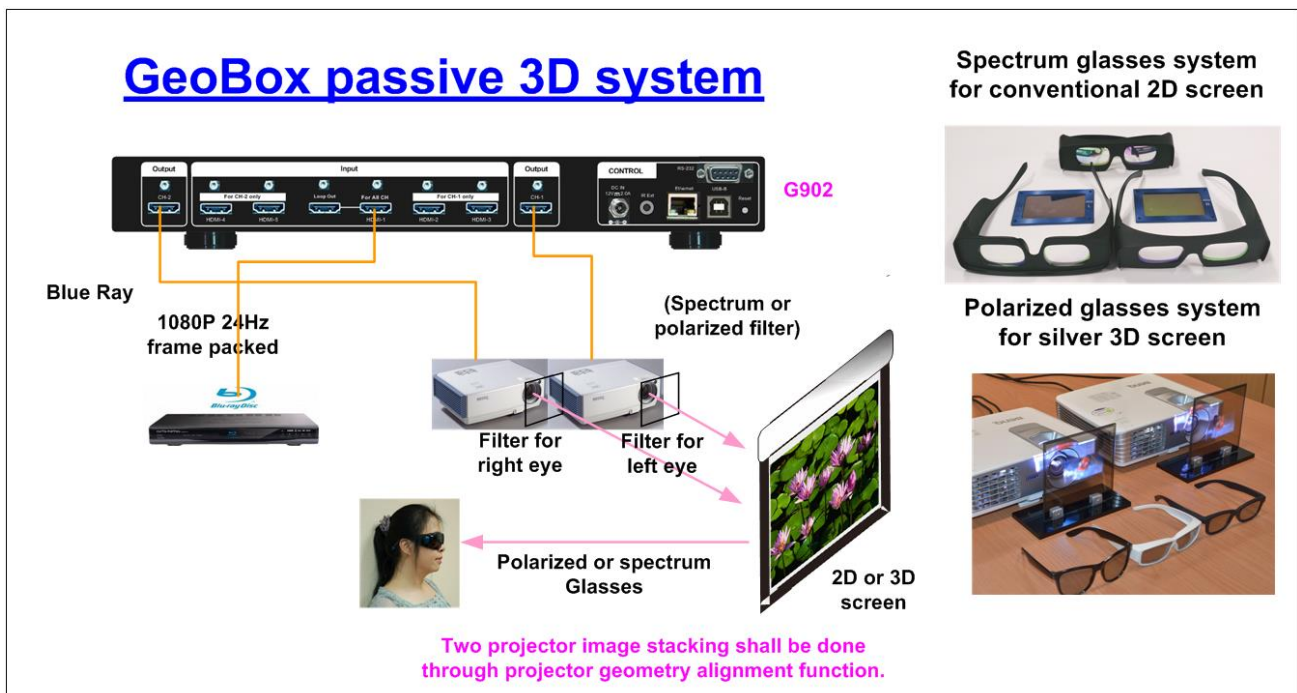

### 16.2. Passive 3D System installation and setup

- GeoBox should not be installed at side of the projector where the ventilation hot air comes out.
- Two projectors can be put side by side or top/bottom. Closer lens position will reduce geometry adjustment range and reduce the loss of the image resolution and brightness. Please make sure hot ventilation air will not affect the other projectors.
- Set output resolutions from 3D signal source as high as possible and connect to HDMI input of GeoBox, then daisy chain connection to another channel.
- GeoBox will decode and distribute RH/LH eye signals for two projectors.

- Install polarized filter at some distance from projector lens to avoid thermal damage (at least 5-10 cm depending on projector lumens). The polarized filter only allows up to 70°C temperature.
- Setup the polarized filter and glasses so that right/left eye can only see the scene for one eye.
- Use projector geometry alignment function to align the images from two projectors completely stacking together. Please place the polarized filter in front of the projector before geometry alignment because polarized filter will affect the light path from projectors. Some deviation is allowed for 3D display but will affect the performance in 2D display.

### 16.3. GeoBox 3D settings

Two sub-menus under [3D properties] menu.

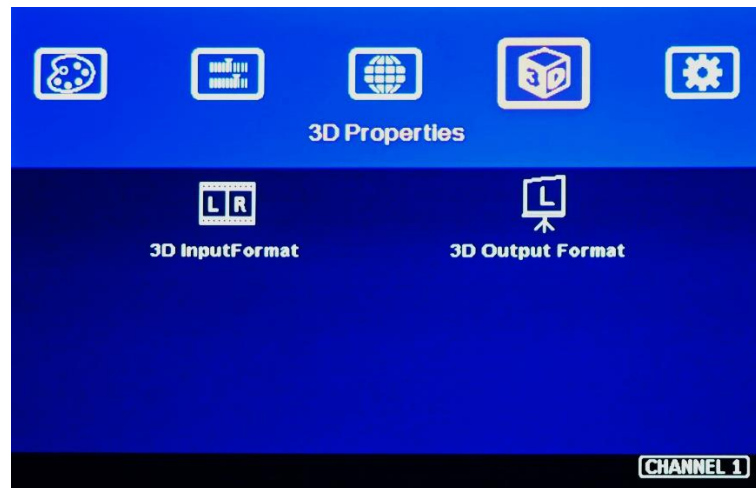

#### 16.3.1. Input Format]

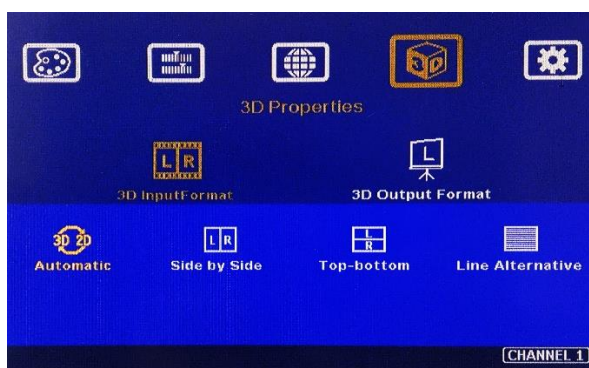

[Input Format] selection:

- ✓ Select [Automatic] if the 3D signal is frame packed or sources with 3D INFO inside the signal.
- ✓ Select [Side by Side], [Top-Bottom] or [Line Alternative] based on input 3D format.

PS. User can apply dual camera RH/LH images as 3D signal source. In this case, please feed each camera output to one channel of G900 to implement passive 3D. User can also execute POP function in one channel to output side by side 3D format for 3D display devices.

### 16.3.2. [Output Format]

- Passive 3D application: To set [Right Eye Frame] for RH eye projector and [Left Eye Frame] for LH eye projector. It should match the RH/LH polarized filter location.
- SBS & T/B outputs are for 3D format conversion. Some 3D display devices can only support specific 3D format. User can select the right format for 3D display device.
- [Sequential] output function is designed for active 3D display. User can select 100Hz or 120Hz refresh rate.

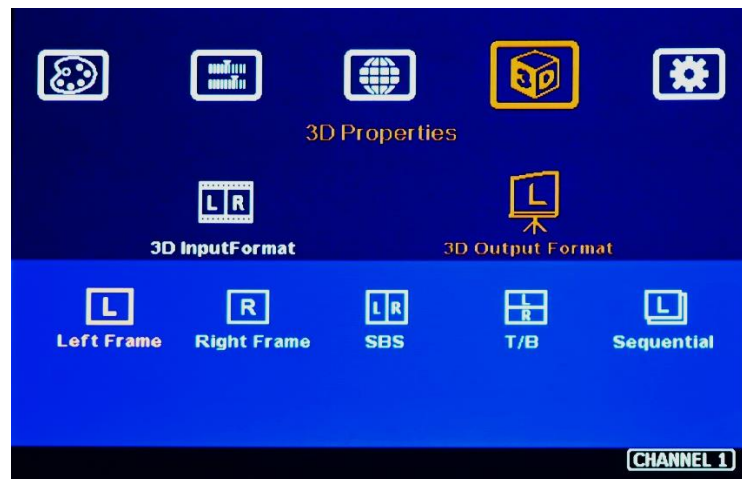

### 16.4. 3D format conversion

G900 can convert side by side, top/bottom, frame packed and line interleaved and dual camera 3D formats into Side by Side, Top/Bottom or frame sequential outputs for passive 3D and active 3D display devices. Some 3D display devices have some limitation in supporting 3D input format. G900 can convert 3D formats into popular 3D format output for these 3D display devices.

### 16.5. Active 3D display

- G900 can convert 3D formats into Side by Side and Top/Bottom outputs for passive 3D or 100Hz/120Hz frame [Sequential] format for active 3D.
- When convert into 3840x1080 side by side 3D signal for active 3D display, please select the output directly from preset mode. The Customize output mode is reduced blanking signal. Some system may have wrong detecting in this kind of 3D signal.

## 17. WebGui and GCT PC Tool (GeoBox Control Tool)

### 17.1. WebGui

WebGui is embedded inside G902. Once user connects G902 with PC through Ethernet, user can access WebGui and execute all operations similar to OSD menu via Virtual Keys and OSD Menu.

- The connection can go through Ethernet router LAN port, WiFi Router or Cross Over Cat 5/6 cable. User can set each unit of G902 with different static IP address (default is 192.168.0.100) in the same domain, then open Google Chrome or Microsoft Edge with IP address to access each unit of G902 for independent operation. User can set different IP address to control multi-units at the same time.
- User can turn on/off the system through WebGui and see the status through power indicator.

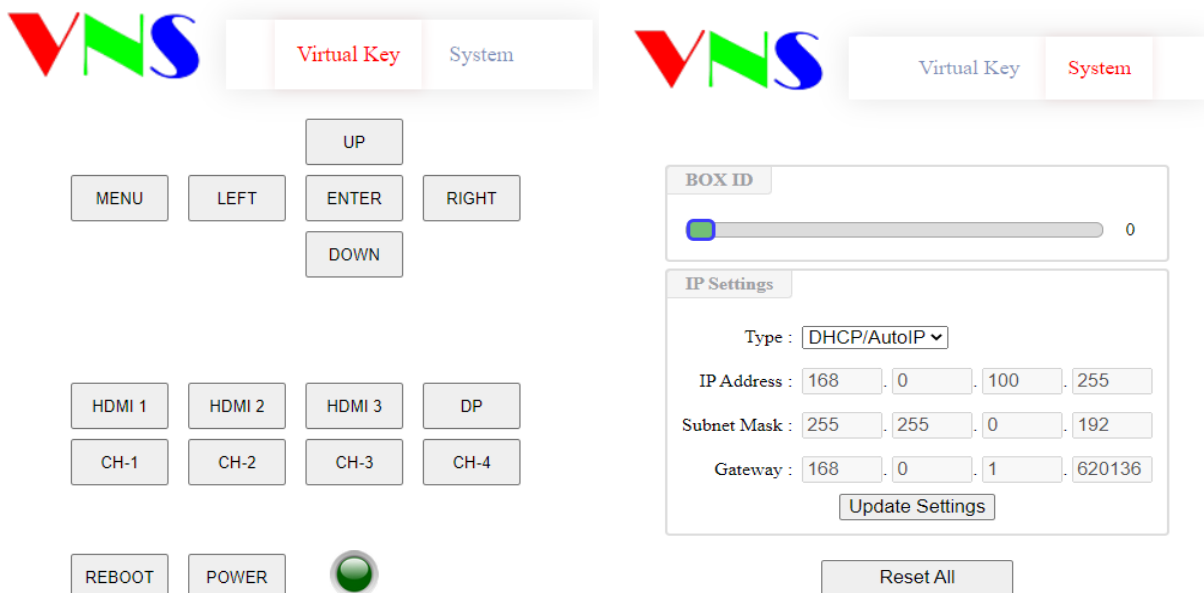

## 17.2. GeoBox Control Tool (PC Tool)

- GCT is a PC tool executed through PC. User needs to download this tool from VNS website. Once user connects G902 with PC through Ethernet or USB and open GCT, user can access GCT and execute all operation similar to OSD menu through PC keyboard and mouse. User can also backup system setting in PC and restore/copy to other units.
- GCT synchronizes the settings parameters inside GeoBox. User can swap the operation between GCT and remote controller.
- User can execute full operation functions and also update Firmware and MCU code through GCT. User can control multiple units at the same time through change IP address.

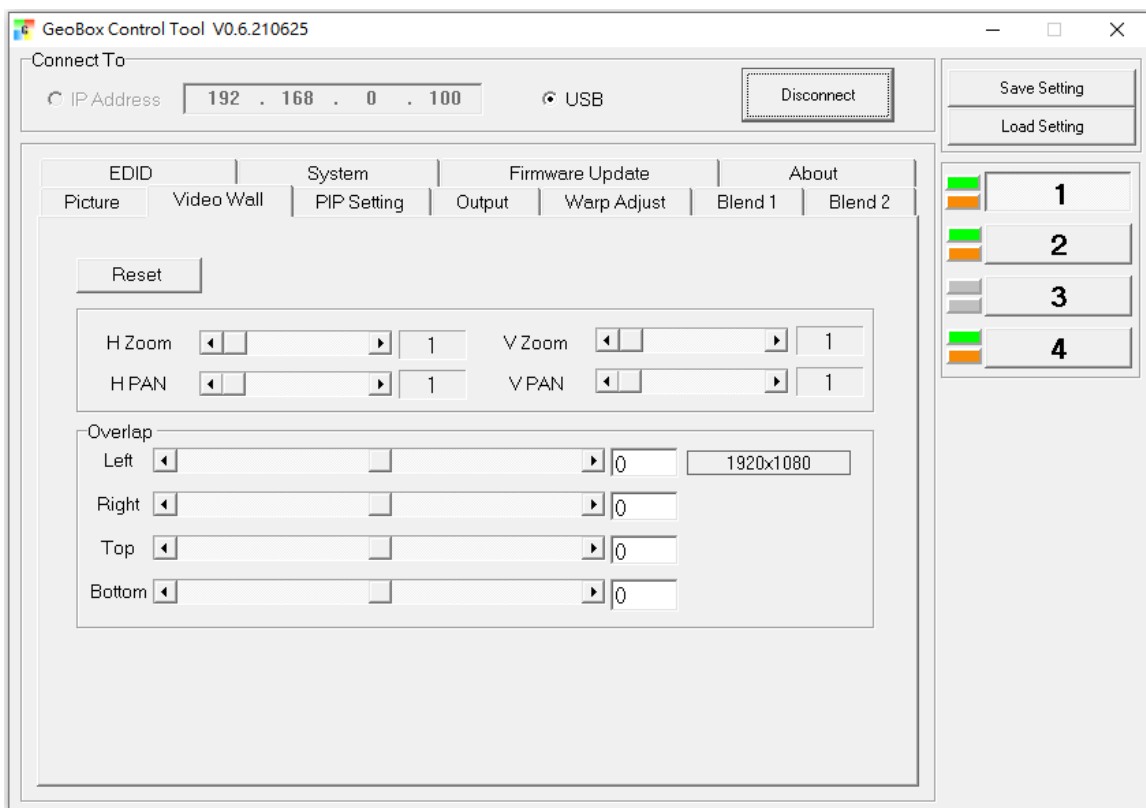

## 18. Save System Settings through Remote Controller

- After finishing system settings, user can save the setting by OSD menu through [Menu]→ [Options]→ [Setting]→ [Profile]→ [Save]→ [Index 1-10].
- User can use [Save] hotkey + Number key on remote controller to save settings directly.
- 10 different display settings can be saved to [Profile]. The data stored in Profile include EDID setting, input source, output resolution, color settings and all user customized settings.



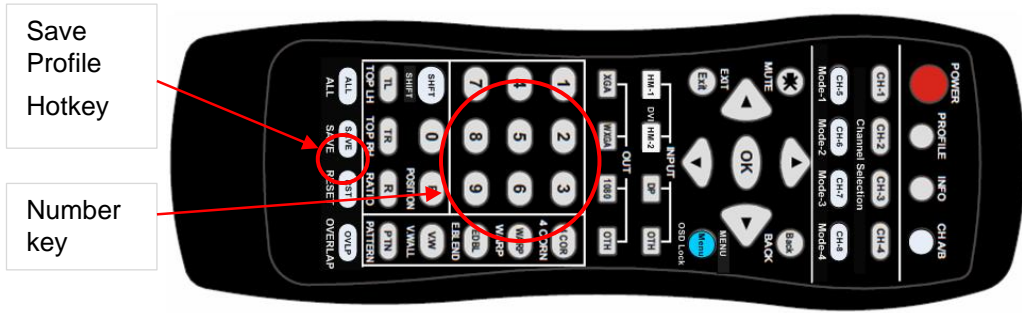

- When user power off the system, G902 will save user setting without loss even the setting is not saved into Profile Index, unless someone to change the setting.
- When system has been reset from OSD menu or update new Firmware, Profile data will still be kept inside G902.

### 19. Load Profile Index through Remote controller

- Press [Profile] shortcut key → Select number keys 1-9 to recall Index 1 – Index 9.

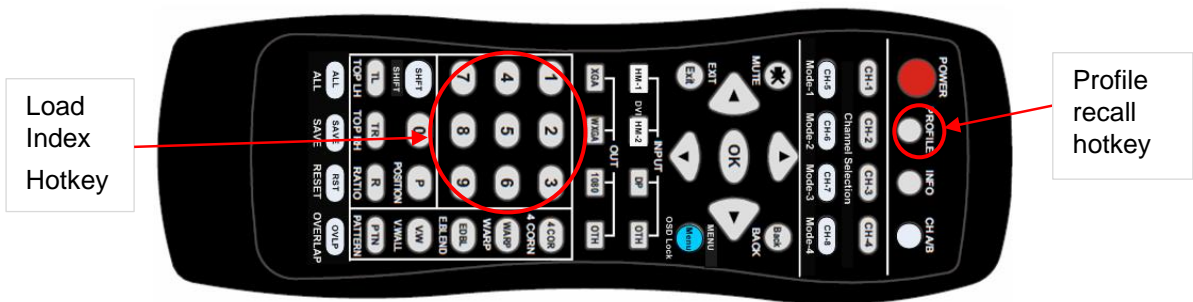

## Application case study

### 20. Multi-viewer application

Through the combination of PIP/POP, 1/3:2/3 POP and 3/4 split view functions, G902 can serve as multi-viewer for UHD monitor at portrait or landscape directions. User can use multiple units of G902 to create more MultiViewer applications, such as 6 split views and 9 split views in one monitor.

#### 20.1. 3 split views & [SBS 2/1] in one UHD monitor

- 3 split view function is integrated in G902. User can display 3/4 split view in one UHD monitor.
- For portrait monitor application, user needs to rotate the main image through [Image Properties] → [Orientation] menu and rotate Sub-image through [PIP Setting]→ [Orientation] menu.
- User can adjust aspect ratio or cropping area for main image through [Video wall]→ [Overlap] function and adjust sub-image aspect ratio or cropping area through [Image Properties]→ [PIP Setting]→ [Overlap].
- User can adjust center sub-image size to change the split position of the center image to get one 16:9 image at the center position. [SBS 2/1] split position can't be shifted.
- User can also use [PIP Setting]→ [Overlap] to create border among main and sub-images.
- The background color in blanking area and image border can be blue or black which is selected through [Option]→ [Accessibility]→ [Black screen].



**3 Split Views [POP3]**



**3 Split views [POP4]**



Below is system connection to build one 3 split views for one UHD monitor with one channel in G902.

- Three signal sources are connected to CH1 HDMI-1, HDMI-2 and HDMI-3, then implement 3 split view function.
- Connect CH1 output to monitor.
- CH2 is spare for another application. User can connect the output from CH1 to HDMI-4 and add another signal source into HDMI-5 to create PIP image on 3 split view window.

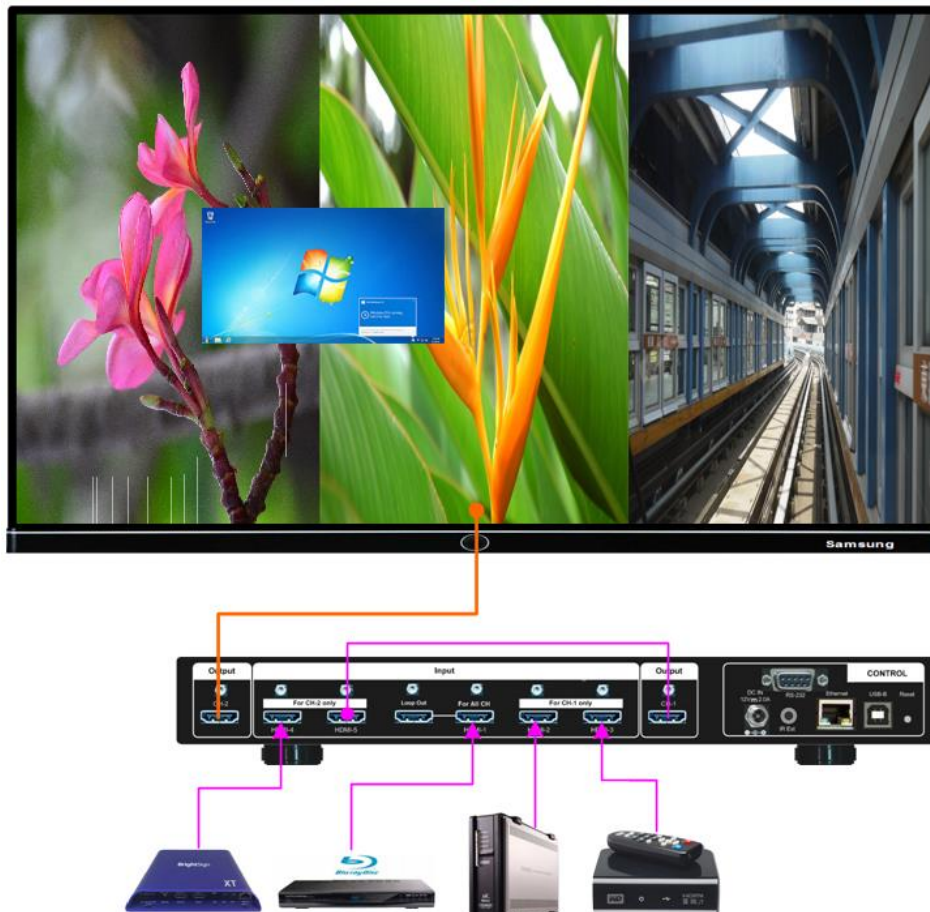

### 20.2. 4 split views in one UHD monitor

- Due to input port limitation, user needs to use two channels to achieve 4 Split view function. User can apply [4x Split] or [4x T/B] + one [PIP] to get the same result.
- User can use single channel processor G901 or S901 to achieve the above [4x Split] and [4x T/B] functions.

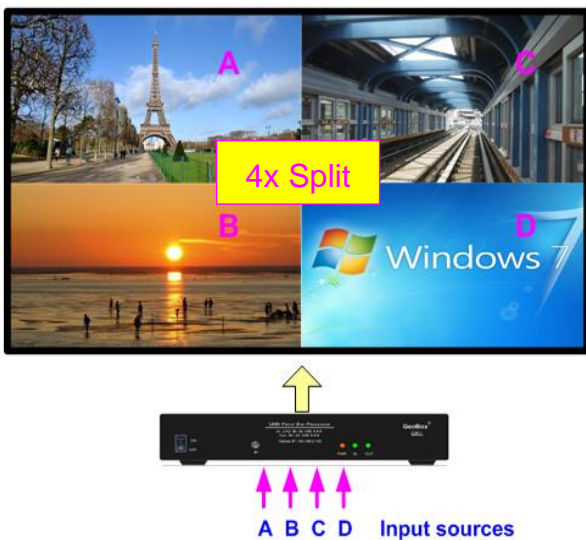
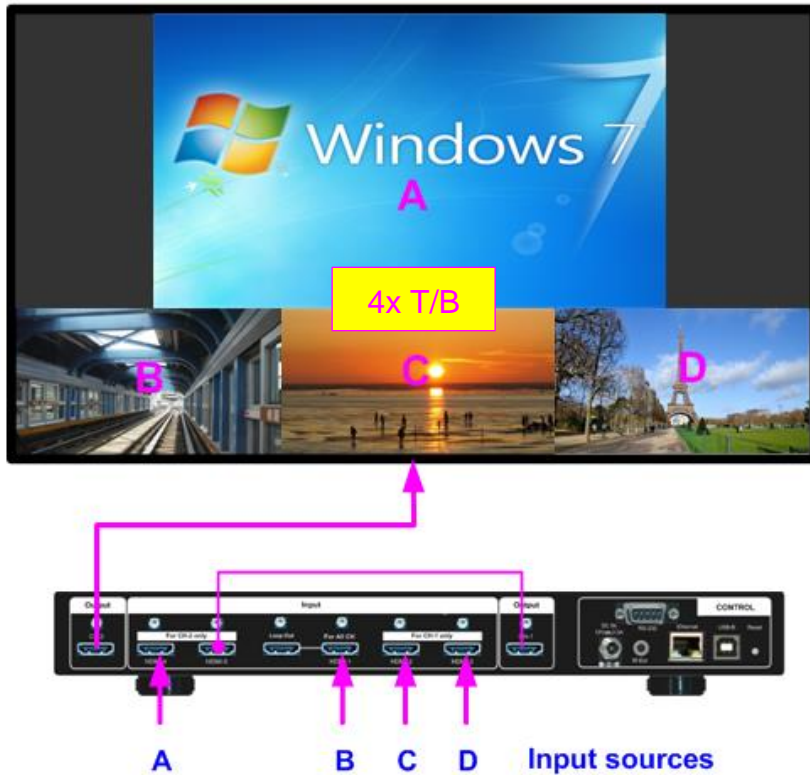

## 21. Conventional Video Wall application

### 21.1. Case study A--Conventional 4k video wall

- User can connect 4k LCD panel with any output from G902, then use [Pan] to assign the location. User can also apply [Overlap] to do image position fine-tune and bezel correction.
- User can also do another setting to display different content in each monitor by selecting different input ports.
- After finish the settings, user can store it into different [Profile] Index. By pressing [Profile] key on the remote controller, user can switch the setting based on requirement at any time.

4k video wall

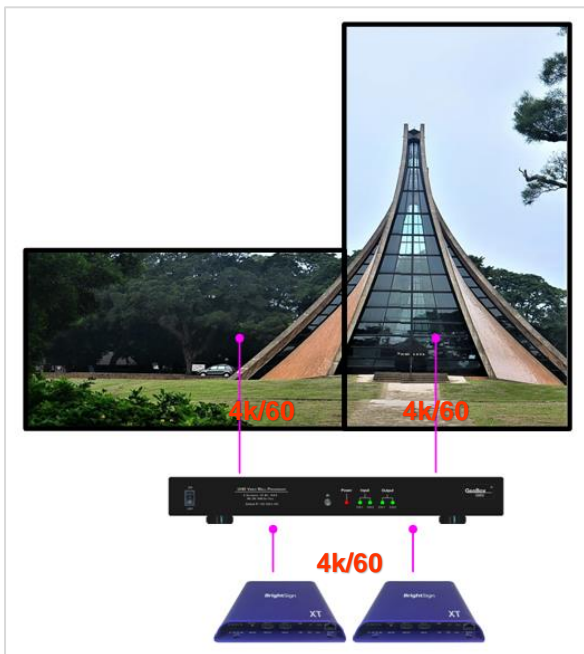

Independent true 4k/60 content in each 4k monitor



### 21.2. Case study B—Video wall with PIP in each monitor

- G902 can execute video wall with one content across entire video wall.
- Besides one content video wall, user can also add one PIP image into each monitor. This PIP image will maintain original size without affecting by video wall ZOOM setting.
- User can change the size and location of this PIP image. The maximum size of the PIP image is up to 1920x1200 that can occupy full screen of the monitor if the monitor is FHD.
- The PIP image can't across two monitors.

Video wall with PIP

Each monitor displays different PIP images

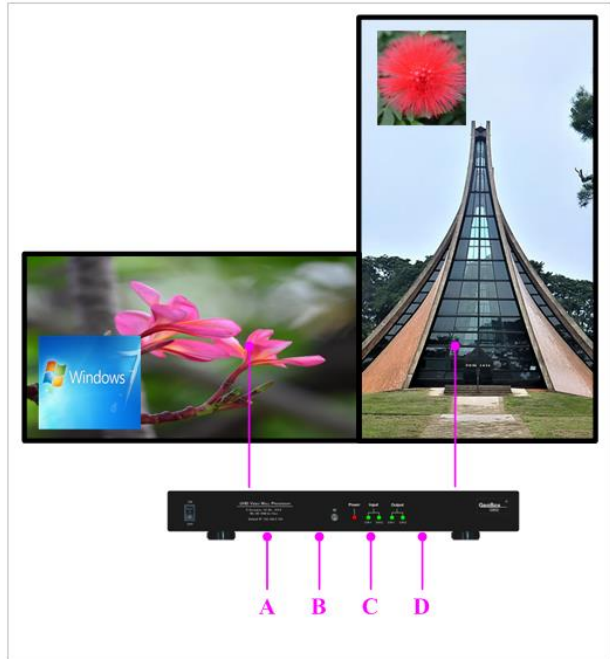
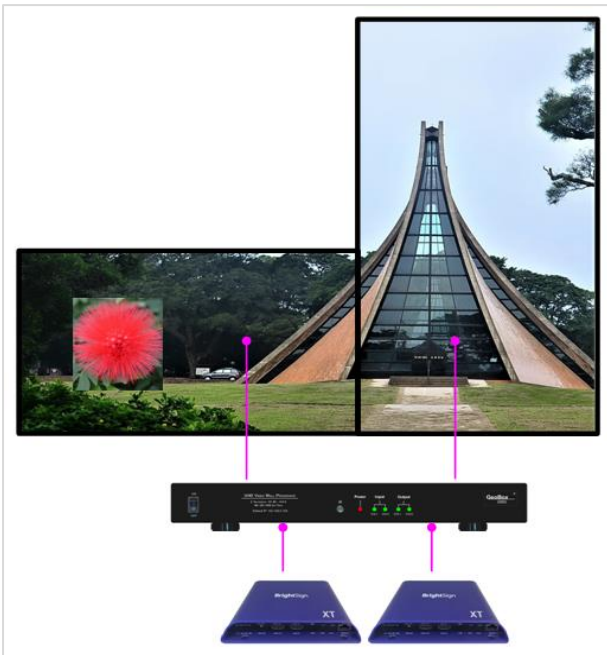

**21.3. Case study C—True 8k/2k video wall with 2 UHD monitors**

- G902 can support 7680\*2160 @30Hz input signal with two 4k/2k output for two UHD monitors to get pixel by pixel true 8k/2k video quality.
- Each LCD monitor can also display two different contents by PIP/POP function.
- The monitors can be installed at portrait direction to become 1x2 video wall with 2160\*7680 input resolution. The image in each monitor will be rotated by G902 separately.

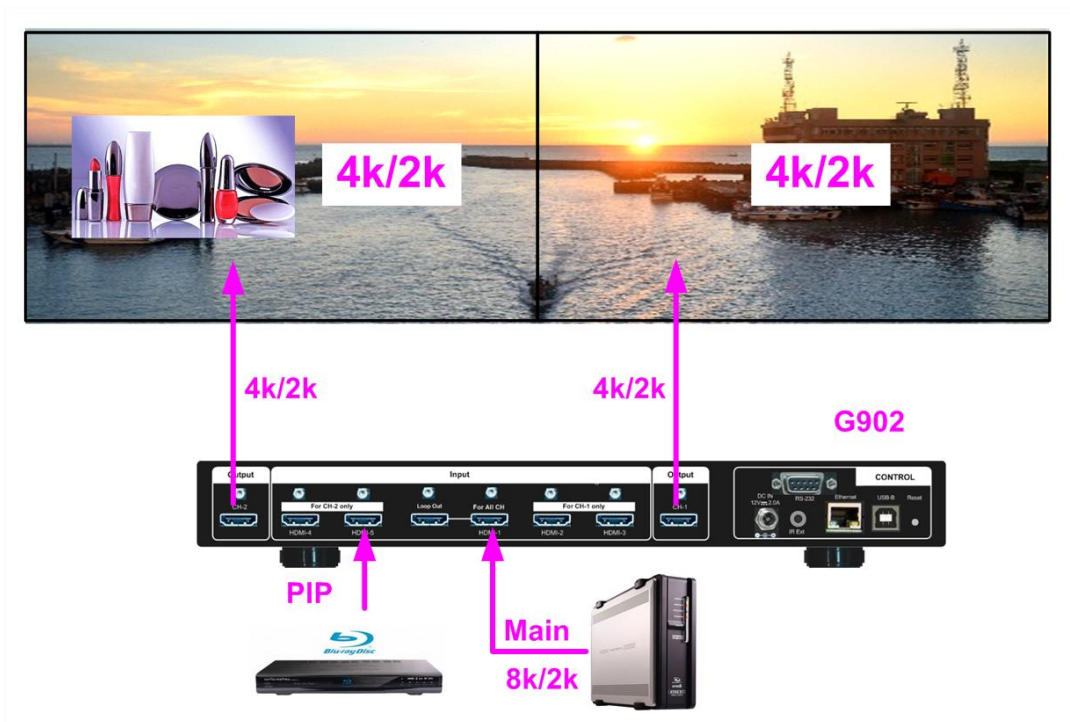

## 21.4. Case study D—Multiple units cascaded to build different size video wall

- Below example is a six monitors' video wall to be built by one G904 (4 channels) and one two channel processor G902. There is no limitation in the cascade.
- Each monitor can display PIP/POP images or even multi-viewer in each monitor.

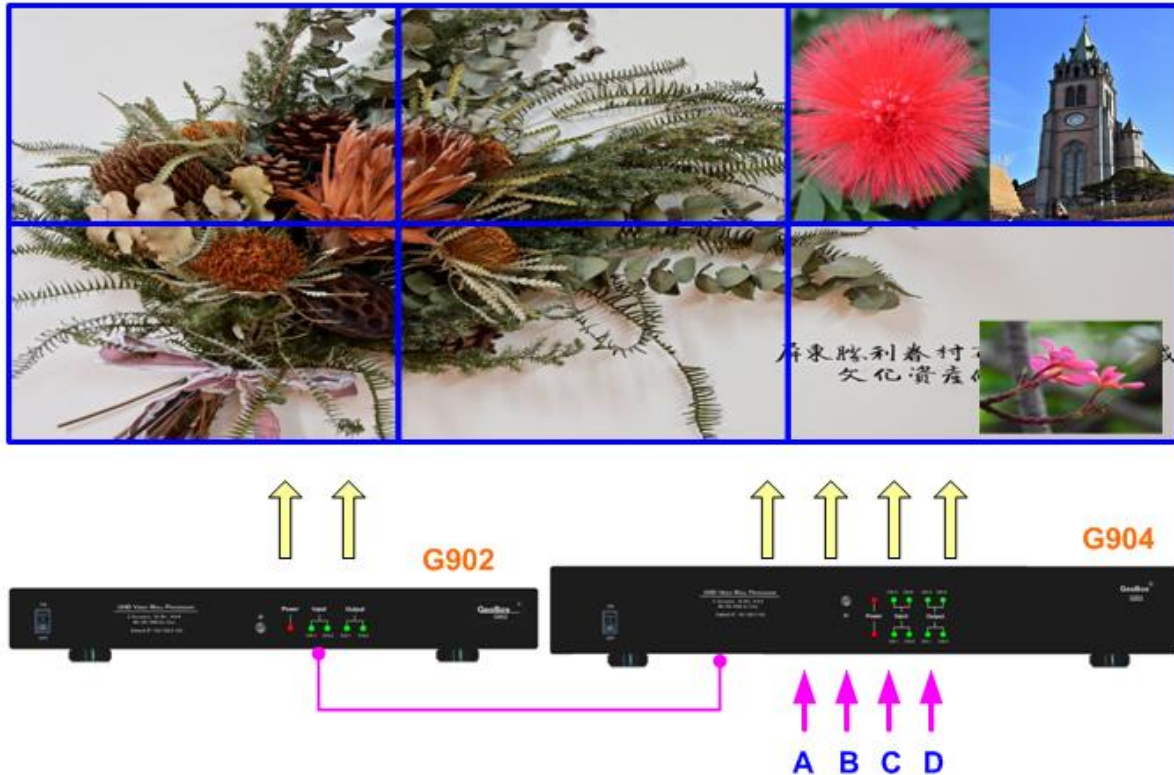

## 21.5. Case study E—Various video wall with monitor at landscape and portrait

- G902 can rotate the image at 90/180/270 degrees independently in each channel. It can build video wall with monitors at landscape and portrait directions at the same time.
- Each channel can crop any location of the image and adjust the bezel compensation, aspect ratio and image position separately to build various types of video wall.
- G902 can support up to 7680x2160 or 2160x7680 input resolution. It is an ideal solution to build video wall with super wide or super high video wall and still keep high resolution and superior video quality.
- In normal applications, user can combine different models of G900 based on the total number of monitors.
- When multiple units are required, user can apply one signal source to the first units of GeoBox, then daisy chain connection to the next unit through loop output port. It is not necessary to add additional image splitter.

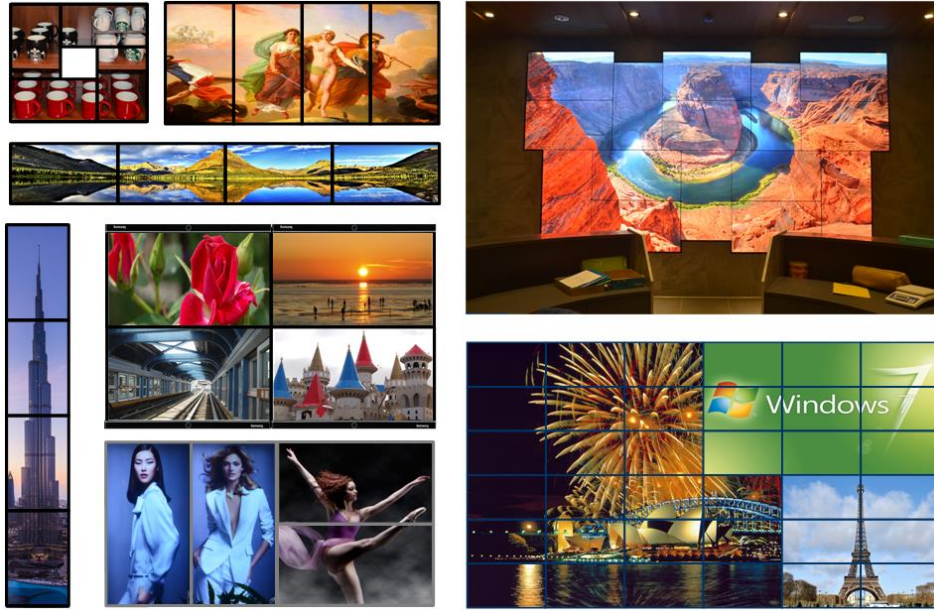

## 22. Creative Video Wall application

- G902 can crop any image and assign to each monitor through video wall Zoom, Pan and Overlap function. Image also can be rotated at 90/180/270 degrees.
- Using the above functions, G902 can create all kinds of creative video wall with 4k or FHD monitors. The monitor shall be installed at landscape or portrait location.
- The signal source is fed to all channels through loop output port daisy chain connection.
- User can add another image to each monitor to create another display style through PIP/POP function. The signal source can be up to 4k/2k 60Hz.
- User can store different settings into Profile and recall through remote controller at any time.

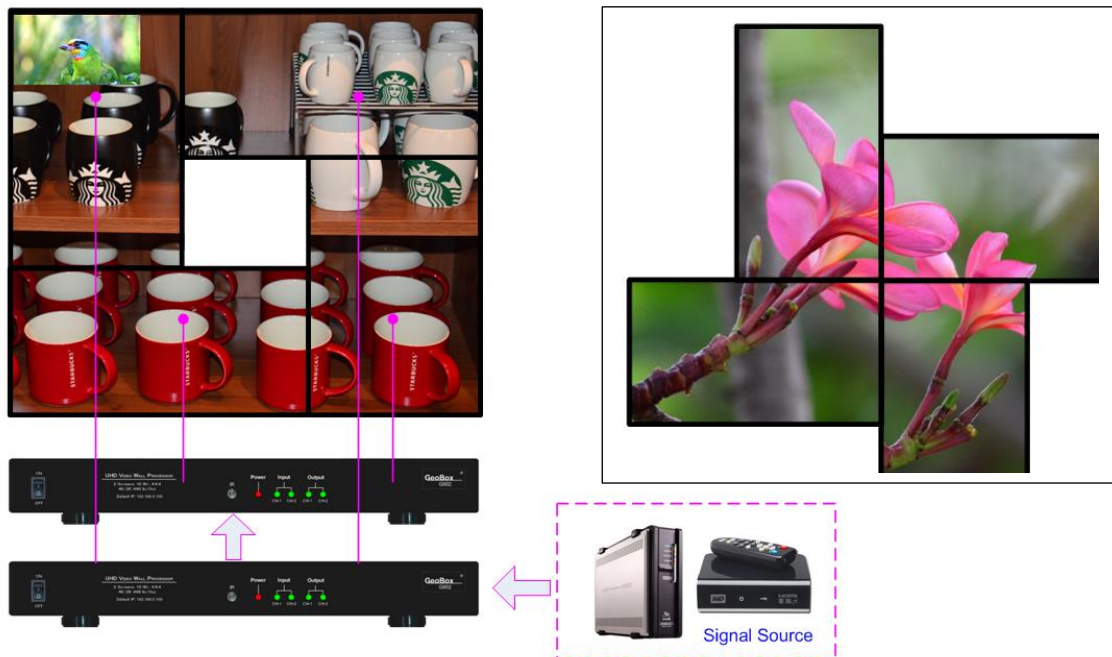



## 23. LED application: Split and crop image for LED display

- If user wants to get the best video quality, the resolution in the content, signal source, GeoBox output and display system should match together.
- LED display system resolution is based on the number of the display module. It is not fixed resolution like VESA standard, such XGA, WXGA, WUXGA, 1080p or 2160p.
- Media server, Blue Ray player or media player can only output standard VESA or video timings. It doesn't have flexibility to output specific timing based on the requirement in LED.
- G902 can crop the right image from any video and output the timings that can match the system resolution of the display device to get the best video quality.

### Case study:

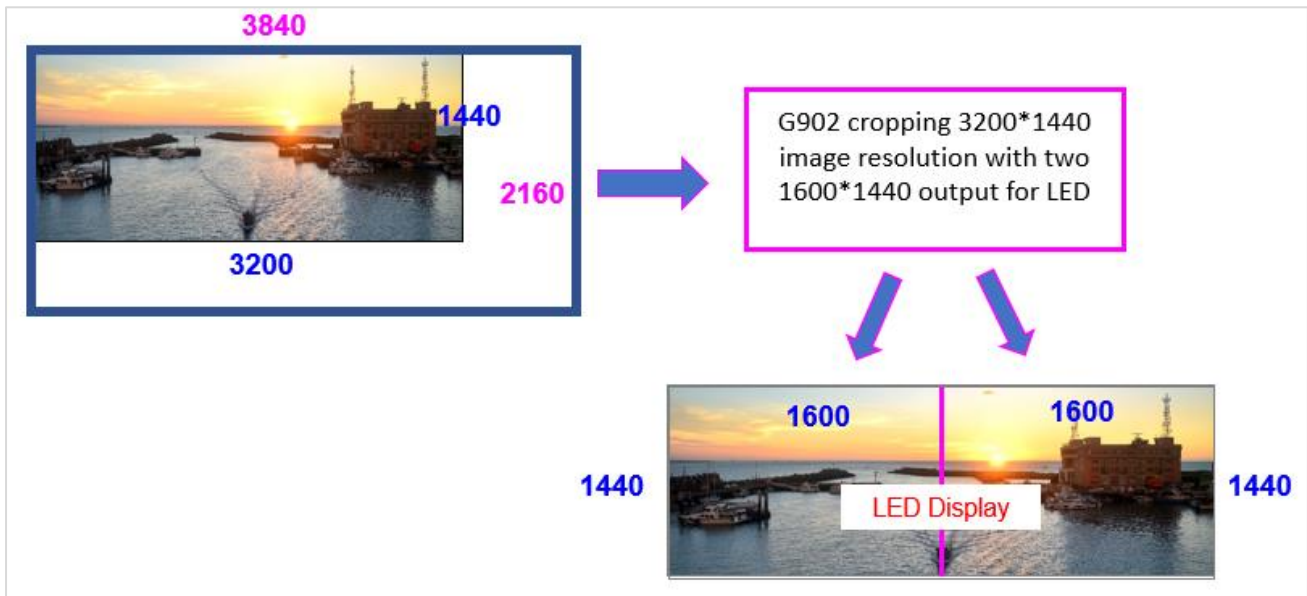

- Below are the procedures to crop and set 3200\*1440 output timing from 3840\*2160 input source and split into two 1600\*1440 resolution outputs for LED controller.
- G902 output settings shall be the same as LED module resolution to get the best video quality. Please set 1600\*1440 as the output resolution in each channel.

### Video Wall settings

**ZOOM:** H= 2, V= 1, to split horizontal pixels 3840 into 2 sections, each section with 1920 pixels.

**PAN:** to assign the split image section to each LED.

**OVERLAP:** The required resolution is 1600 pixels and split image is 1920 pixels in each section. We need to use Overlap function to adjust the cropping location for each LED.

### LED-1:

**PAN:** H=1, V=1

**Overlap:** RH edge:  $1600 - 1920 = -320$  (Required 1600P, split 1920P, need to reduce 320P)

Bottom edge:  $1440 - 2160 = -720$  (Total image height: 2160P, required 1440P, need to reduced 720P)

**LED-2:**

**PAN: H=2, V=1**

**Overlap:** LH edge:  $1920 - 1600 = +320$  (start point needs to be shifted to left 320P)

RH edge:  $3200 - 3840 = -640$  (final image location need to be shifted to left 640P)

Bottom edge:  $1440 - 2160 = -720$

**Output resolution settings in each channel:**

User can set output resolution with 1600\*1440 by programmable output settings from OSD menu under [Image Properties]→ [Output]→ [Customize].

## 24. Front end processor for large display

### 24.1. Split 8k/2k image for 4k projector edge blending



- G902 can split the source image and assign to each projector as well as set overlap pixels for edge blending based on the overlap region.
- The projectors require warp and edge blending functions. If the projectors have no warp and edge blending function, user can use GeoBox edge blending processor to implement complete edge blending function.
- G902 can output 4k/2k signal for 4k projector. It should be a perfect match.

## 24.2. Adjust aspect ratio and add PIP in projection system

- G902 can split the source image and assign to each projector as well as set overlap pixels for edge blending based on the overlap region.



- 3x 4k/2k contents are connected to G902
- CH1 executes PIP then output to CH2.
- CH2 executes another PIP then output to M802
- M802 executes edge blending with dual PIP images
- All signals can be 4k/2k @60Hz 4:4:4
- User can display two side by side images across entire screen as well.



- Flexible aspect ratio adjustment is available in G902. Main image aspect ratio adjustment will not affect sub-image
- 16:9 image can be displayed in the center of edge blending system.
- Two PIP images can be located at any position across entire original screen.

### 24.3. 3 split views in projection system

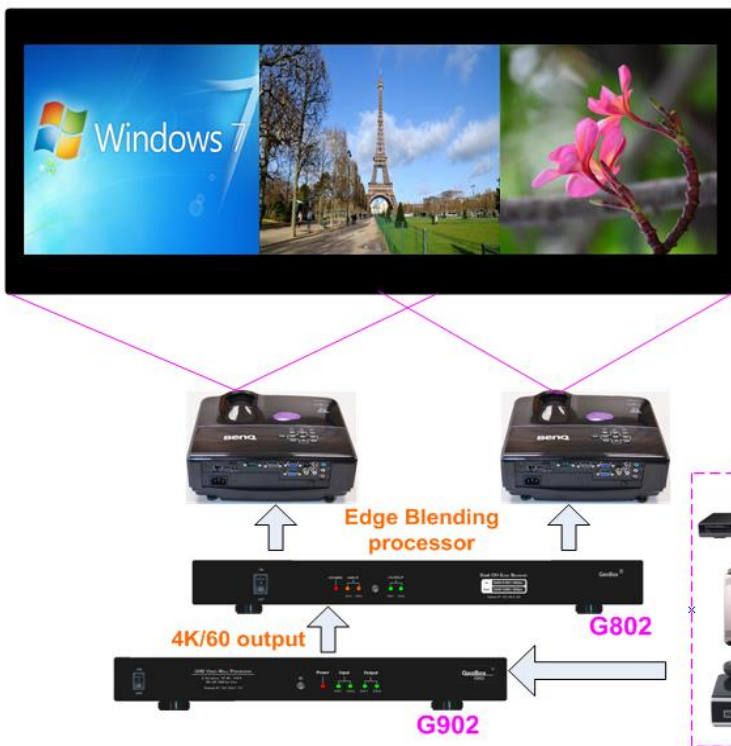

- 3x 4k/2k contents are connected to G902
- CH1 executes [3x SBS] then output to G802.
- G802 executes two projector edge blending.
- If necessary, user can output G902 CH1 to CH2 and use CH2 to adjust aspect ratio or add another PIP image into the screen.
- All signals can be 4k/2k @60Hz 4:4:4

## Technical support

## 25. Trouble Shooting

### 25.1. No image or unstable image on the screen

- G900 output resolution is 4k/2k/60Hz and the monitor can't support 4k input, user will see no display image in the monitor.
- Please use remote controller or front panel output selection keys to select [1080] or lower output resolution to let display device be able to support it.
- Please check input/output LED indicators and make sure all the signals are correctly connected.
- If user still can't see the image, please click [Menu] key to activate OSD. If user can see normal OSD, the system should be normal. Please click [INFO] key to check input and output timings.
- If user still can't see the image, please change signal source, HDMI cable or display device to find the root cause of the failure.
- HDCP may be the reason for no image. Please make sure display device is HDCP compliant.
- Many HDMI extenders can only support up to 4k/2k @30Hz. Please select correct HDMI extender based on your requirements.

## 25.2. Intermittent or loss of input signal

- Check the HDMI cable quality and make sure all cables are fitted correctly. 4k/60 signal requires 4k/2k certified cables.
- Cable length: Connecting cable length should be as short as possible. Replace a short cable to verify the possible root cause. Usually, the longest standard 4k/2k HDMI cable is only up to 10m.
- HDCP compliant issues: If the input source or the monitors are not HDCP compliant, it is possible to stop G900 from negotiating HDCP link and show intermittent, abnormal or no image. Please check HDCP condition in signal source or display device.
- Resolution issues: check if signal source and connecting cables can provide source signal supported by G900.
- DVI/HDMI signal compatibility: some display devices may only support DVI video signal. The default output is HDMI. User can change output with DVI format through [Options]→ [Setting]→ [DVI]→ [On] to test it.
- Usually, to swap with different cable, output channel, signal source and monitor can verify the root cause for the failure.
- It is possible to have signal compatibility issue. User can add one HDMI splitter/switcher in the middle to change signal impedance. It may fix the issue.
- We propose to use signal enhanced cable, HDBaseT or Optical Fiber cable for long distance connection. Conventional 4k/60 HDMI cable can't support more than 10 meters. If using optical fiber cable, user may need to set DVI output to get smooth transmission.
- User can connect a monitor at the end of the Loop out port to check signal source stability.

## 25.3. Video quality issues

- Try to use the highest signal resolution and number of color bits (RGB 4:4:4) allowed by G900. Please click INFO key to verify input/output resolution.
- There are a number of lower-quality AV players, the specification and actual output are difference. These media player may be designed with lower color sampling bits or poor image compression technology, resulting lower image quality or lagged image.
- If use of H.264/H.265 compressed files, please select a player with hardware decoding to get smooth video quality.
- If the input signal is interlaced signal (interlaced-1080i), and the image is rotated, then the channel will have no [3D Motion adaptive de-interlaced] processing function. If user applies static image source, the output video may have slight jitter phenomenon. The processing channel quality will be reduced. Use a progressive signal source setting (1080p/2160p) whenever it is possible.

- Please press [INFO] shortcut key to check the input/output signal settings.
- User can select [Image Properties]→ [Output]→ [Deep Color] to set 10-bit signal output. It will smooth the gradient color when the input signal is also 10-bit. Please note that HDMI 2.0 can only support 4k/2k 60Hz 8-bit 4:4:4 signal only.
- If possible, please apply 60Hz signal source. User can see smoother image while image is panning or in fast motion. User may see jitter image in 24/30Hz input source.

#### **25.4. Abnormal display in Front Panel LED indicators**

- User should see Input / Output LED light. If no LED light or LED is intermitting, please check Input / Output connecting cables, signal source & monitor.
- If continuous flushing in Power LED indicator with 1.0 second interval, the OSD menu has been locked. Please press 850 number keys in remote controller to disabled it. If the flashing time interval is 0.5 second, please press [MENU] key on remote controller for 5 seconds to unlock OSD menu.
- If Power LED turns to Red, please open the system through remote controller POWER key.

#### **25.5. Synchronization issue in the outputs**

- While using multiple units for video wall applications, please enable [Frame Sync] menu under [Options]→ [Setting]→ [Frame Sync] → [Normal].
- The input refresh rate should be the same as output refresh rate so that the system can implement Frame Lock to synchronize all the outputs from multiple units. If the input source is 50Hz with 60Hz output, it is possible to see some synchronization issue.

#### **25.6. Call for technical support**

- User can send e-mail to support@vnstw.com together with as much information as possible.
- The following information is required for a swift response.
  - Sink device (monitor): type and model number
  - Monitor layout or specific application details (shape of video wall).
  - GeoBox model No. and series No.
  - Detailed timing of signal source and resolution.
  - Press [Info] key to get System Information and send the data to us, including input/output timing and F/W version.
  - The exact nature of the problem. Please be as detailed as possible.
  - If possible, please attach the Pictures of the issue.
- Usually, we will response with 24 hours (excluding weekends)
- Please note that if the machine is sent back for repair, user needs to pay for delivery cost.

## 26. Safety Precaution and Maintenance

### ➤ **Power Supply**

Please connect electric power for all devices in the system from the same Power Distribution Box with correct grounding. Open the power after finishing system connection to reduce the risk for system damage from high floating voltage.

### ➤ **Working Environment**

Please locate G406 in an environment free from dust, moisture and high temperature with good ventilation.

### ➤ **Maintenance and Repair**

Apart from what is detailed in User Guide, maintenance should be carried out by competent technician assigned by VNS. If G406 is physically damaged, it should be returned for repair using VNS RMA procedures. If the unit is opened by user, it will lose the right for warranty protection.

## 27. Warranty and RMA policy

### 27.1. Warranty and RMA policy

This device is designed and tested to the highest standards and backed by two years' parts and labor warranty. Warranties are effective upon the first delivery date to the end customer and are non-transferable. Warranty period extension is available up to 5 years through paying extra charges.

### 27.2. RMA policy

#### **Return Material Authorization (RMA)**

In the event that a product needs to be returned for repair, inform manufacturer and ask for a Return Material Authorization number.

RMA procedures:

1. Prior to returning any item, user must receive a Return Material Authorization (RMA) number.
2. All RMA numbers must appear on the return-shipping label.
3. All RMA numbers are valid for ten (10) days from the issue date.
4. All shipping and insurance charges in all RMAs must be prepaid by the customer.

**Shipping charges and repair fees**

1. Within warranty period: The customer shall pay shipping charges when the unit is returned for repair. Manufacturer will pay shipping charges for return shipment to customer. All the inspection, material and repairs fees shall be borne by manufacturer.
2. Outside warranty period:
  - User shall pay for the inspection, material and labor cost for the repairs and pay for all shipping freight and insurance cost.
  - Manufacture shall give quotation to user and user can make decision whether this repair shall be executed or not. If user decides to return the unit, user shall pay for the return cost.



## **Specifications**

- ✧ Input & output: 5x HDMI 2.0b input ports, 2x HDMI 2.0b output ports and 1x HDMI 2.0b loop port for daisy chain connection.
- ✧ One common input port with Loop out function shares the input signal for two output channels at the same time.
- ✧ Each channel has two other independent input ports. These input ports only provide signals for individual channel.
- ✧ Loop out port is raw signal from common input port. It can be daisy chain up to 10 processing modules without HDMI splitter to build big scale display system up to 20 monitors.
- ✧ Max. input: 4096\*2160 @60Hz, 7680\*2160 @30Hz or 2160\*7680 @30Hz (up to 600MHz).
- ✧ Supports interleaved and progressive input signals with 4:4:4 10-bit color under 600 MHz.
- ✧ Support High Dynamic Range (HDR): SMPTE ST-2084, SMPTE ST-2086 and BT.2020 HDR 10 input signal processing.
- ✧ Support non-VESA standard input timings.
- ✧ Preset 17 output timing modes with selectable 8-bit/10-bit color and HDCP control settings.
- ✧ Programmable output range is from 800-7680 in horizontal (with 8 Px/step under 230Mhz, 16 Px/step above 230MHz) and 600-3840 in vertical (with 1 pixel/step). Max. programmable Output: up to 4096\*2267 @60Hz or 7680\*1234 @60Hz (maximum pixel clock < 600MHz).
- ✧ Selectable refresh rate: 24/30/50/60/100/120
- ✧ Output signal: SDR, progressive full color RGB, 4:4:4, 8/10-bits under 600MHz.
- ✧ HDCP: V2.2/V1.4 in HDMI.
- ✧ Embedded video wall function for image split, cropping, location assignment, position adjustment and precise bezel compensation.
- ✧ Decode 3D signal for passive 3D display and convert 3D format into side by side, Top/Bottom or frame sequential output.
- ✧ One frame latency: 16.6ms (V=60Hz)
- ✧ OSD menu position can be shifted for convenient OSD operation.
- ✧ Programmable EDID in the range at H= 1024-4080 (8 pix/step), V= 720-3840 (1 pix/step).
- ✧ Flexible aspect ratio adjustment in each edge up to +\_ 1800 pixels.
- ✧ Each channel has independent PIP/POP function with PIP image size from 320\*180 up to 1920\*1200 resolution with flexible position, rotation/flip and cropping area adjustment.
- ✧ Display 4 types of 3 split views on one UHD monitor.
- ✧ Display 4 split views for one UHD monitor.
- ✧ Two input signals quick seamless swap in each channel through remote controller.
- ✧ Individual color adjustment in main and sub-images.
- ✧ 1:1 pixel to pixel native image display with original quality.
- ✧ Image Freeze by click keypad on IR controller.
- ✧ Frame lock for multiple unit synchronization.
- ✧ 10-bit processor, 3:2/2:2 cadence, low angle smooth algorithm and 3D motion adaptive de-interlace.
- ✧ High quality scaling engine for image scaling up and down among SVGA to UHD
- ✧ Support xvYCC 8/10/12-bit wide color gamut input signal processing.
- ✧ Individual 90/180/270 rotation, flip, cropping, scaling & color adjustment up to 4k/60 input in main & PIP/POP-image.
- ✧ Embedded HDMI audio output. While implement PIP/POP, user can select audio from main or sub-image.
- ✧ 10 system settings can be stored and backup.
- ✧ ESD Protection: ±15kV (Air-gap discharge), ±8kV (Contact discharge)
- ✧ DC power supply: DC adapter: 12V 3A (100V-240V)
- ✧ Max. Power consumption: 18W
- ✧ Working environment: 45 ° C, 10-90% RH
- ✧ Control: IR, RS232, USB, Ethernet
- ✧ 10 system settings can be stored and backup.
- ✧ Dimensions: 330mm\*162mm\*40mm
- ✧ Weight: 1.45kg
- ✧ CE/FCC/RoHS/UKCA/KC Certified
- ✧ 2 Year Warranty, extension package is available up to 5 years.

## **Revision History**

Revision	Date	Originator	Comments
V1.0	2021-0106	Steve Wang	First version
V1.01	2021-0121	Steve Wang	Add 3 split view function
V1.02	2021-0720	Steve Wang	Add 3D function, seamless input swap
V1.03	2022-0120	Steve Wang	Modify 3D application
V1.04	2022-0121	Steve Wang	Modify 3D application
V1.05	2022-1111	Steve Wang	Modify spec and add 1:1 scaling mode